



High Precision & Torque Control **iV5**
Vector Drive

2.2~37kW (3~50HP) 3 Phase 200~230V
2.2~800kW (3~1,067HP) 3 Phase 380~480V
5.5~500kW (7.5~666HP) 400V DC Input type

Our lives with **STARVERT iV5**

**“The Optimum Solution”
iV5 series provides a full satisfaction
for all the needs**

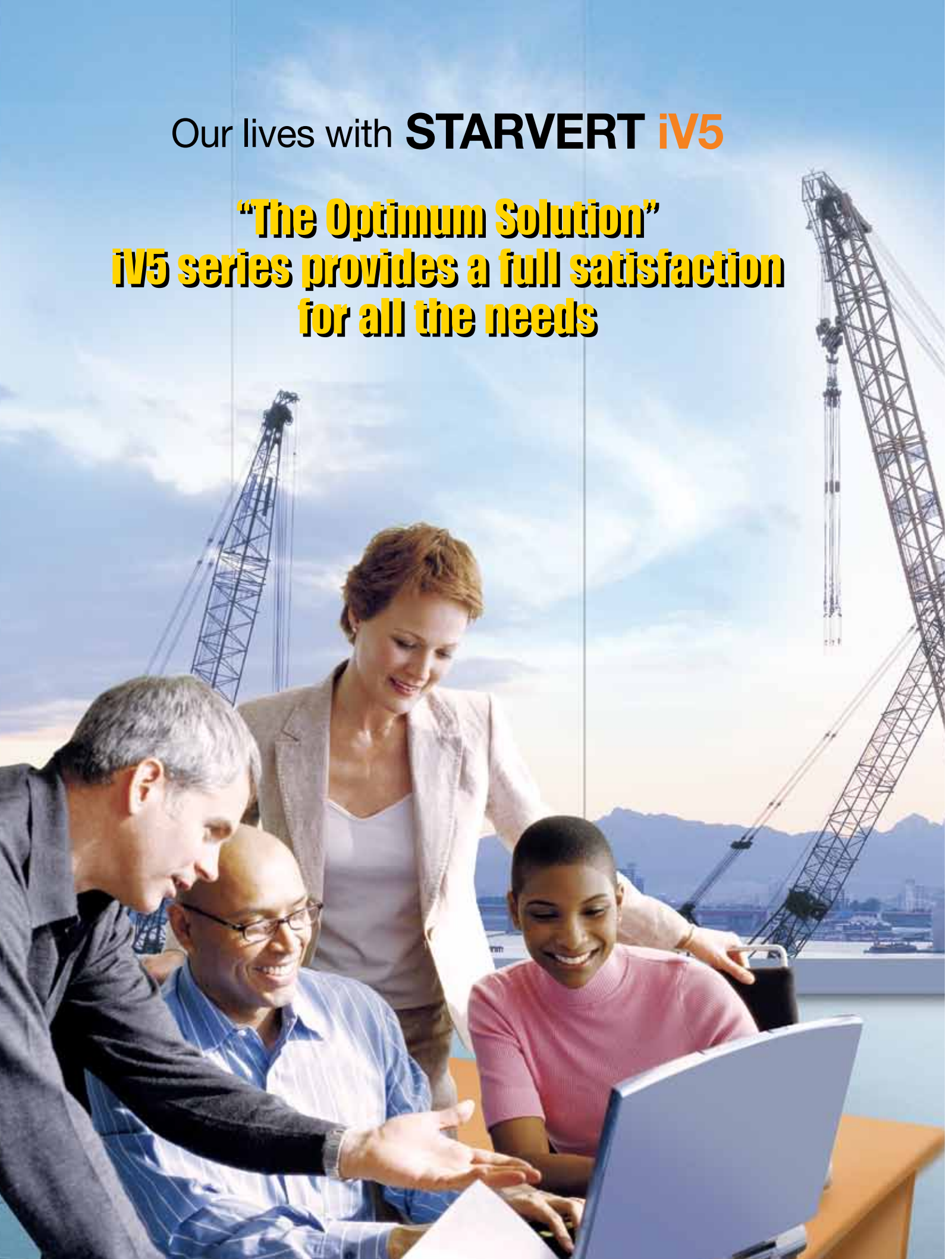



Optimized Solution for System Drive

Control the Crane, Elevator & Continuous line system based on powerful performance



High Performance Control system

Speed/Torque control, SIN/COS encoder, PM Sensorless, Auto tuning, Endat encoder, Draw/Droop/ Process PID Control, Built-in brake control

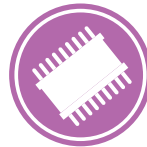

User-friendly Interface

User-friendly keypad, Various field bus option, DriveView management

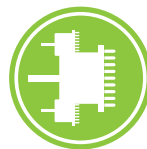

Various Option for System Application

Synchronize, SIN/COS encoder(Endat encoder), Extension I/O, EL I/O option

‘We guarantee, your satisfaction will be beyond your expectation’

iV5 series realizes the high precision vector control in entire operational area and its highly precise speed control guarantees a superb control stability in the crane, continuous line and elevator system controls.



220kW UL Certification ISO 14001, ISO 9001

Contents

04 Features	26 Shifts between each groups and codes in the Loader
12 Model & Type	27 Function Codes Table
13 Standard Specification	47 Braking Unit and Resistor
16 Wiring	49 Dimension
22 Terminal Function	54 Fault Solution and Check
24 I/O Board	55 Basic configuration
25 Loader Use	





Features

Optimized Solution for System Drive

Control the continuous line as Metal processing/Paper & Paperboard, Crane and Elevator system based on powerful performance

System Drive

iV5 provides the optimum system operating environment with various function and superior control performance

Continuous line

Winding/Unwinding System of Metal processing, Paper & Paperboard, Textile, Cable line

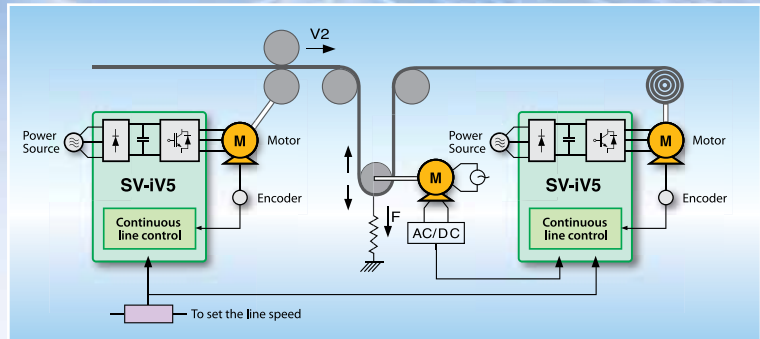

Customized function for continuous line

- Diameter operating
- Taper function
- Splicing control
- Flux/Tension control
- Inertia compensation
- Bobbin random set function
- Quick stop
- To use Dancer/Load cell
- Online set Winding/Unwinding
- Over/Under winding
- Breakage detecting function
- Core fault detecting function

Diameter operating

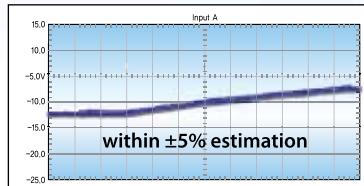

Tension control

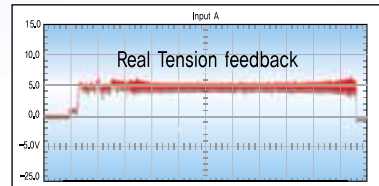

Tension control

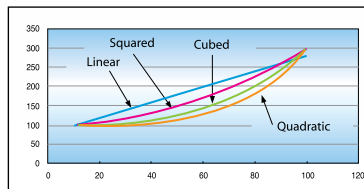

Taper function

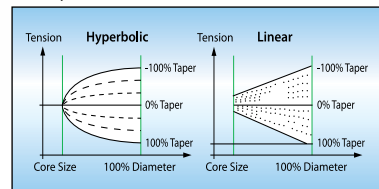

iV5 guarantees system safety and reliability with enhanced protection function and various option

Crane system

iV5 can operate crane system with load balancing, speed/position control, brake control of harbor crane, overhead crane, tower crane, parking system and automation warehouse

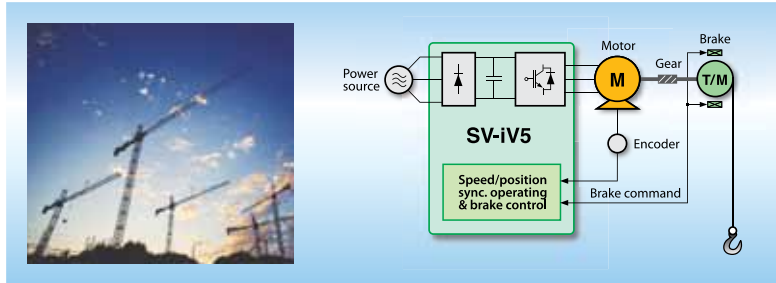

Brake control

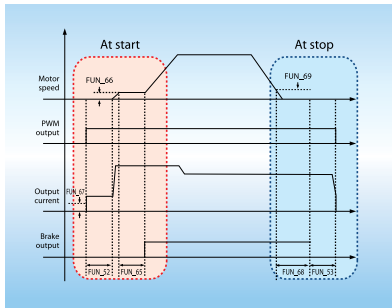

Synchronized operating with speed/position

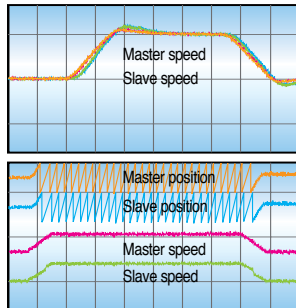

Load balancing with droop control

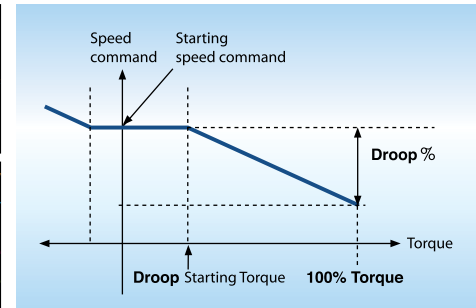

iV5 guarantees comfortable and stable driving with precise position control

Elevator system

iV5 guarantees stable driving and monitoring the elevator with both optimum speed pattern and position control.

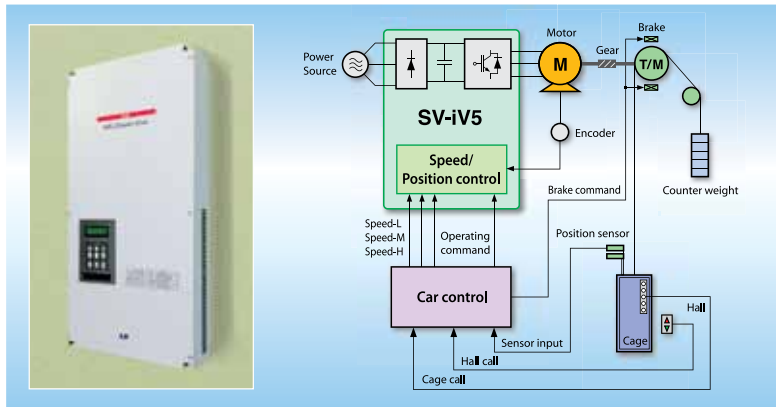

Rollback Prevention : Anti-Rollback Function (without external load cell)

Time Chart for Anti-Rollback Function

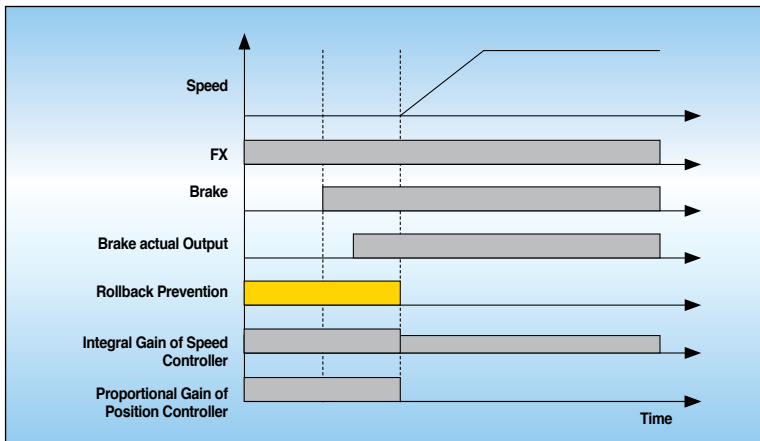

Before Anti-Rollback Algorithm

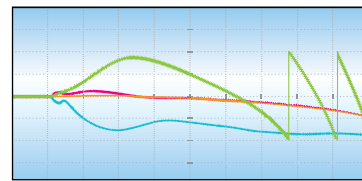

After Anti-Rollback Algorithm

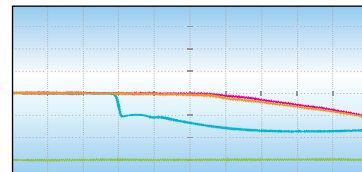



Features

Precise Control

Precise speed/torque control, Accurate control with SIN/COS encoder, PM Sensorless control, Auto tuning(at standstill), Draw/Droop/Process PID Control, Brake Control

High Performance

iV5 guarantees precise speed/position control and synchronous operation in various systems.

Speed/Position Synchronized operation

- Speed/Position synchronizing operation
- Precision synchronizing operation in 5°
- Synchronizing in driving / Synchronizing in starting
- Synchronous operation with multiple motors

(with synchronized option card)

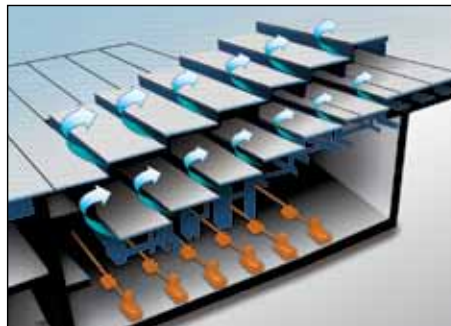

Speed synchronous operation

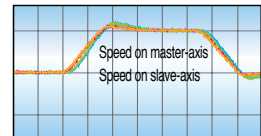

Position synchronous operation

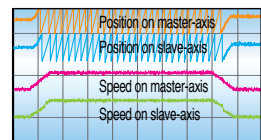

Autotuning

Standstill autotuning

This unique technology of LS allows the autotuning operation to be performed even with the motor shaft directly connected to the load.

Especially, this standstill type autotuning is very useful in the lift application because it does not require removal of brake coupling connected to the motor.

Rotation autotuning

This type of autotuning has been widely used for the vector control drive. As the name implies, this requires the motor shaft to be free of the coupling for a proper operation.

Precise and safe control system

Draw/Droop/Process PID control

Draw/Droop/Process PID control is provided for precise control such as tension control, linear velocity control, temperature and pressure control and useful functions easily implemented like Load balancing.

Draw control

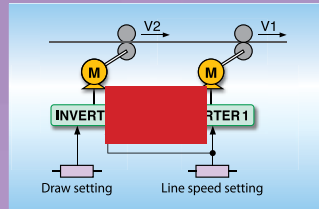

Process PID control

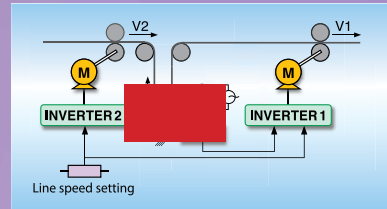

Droop control

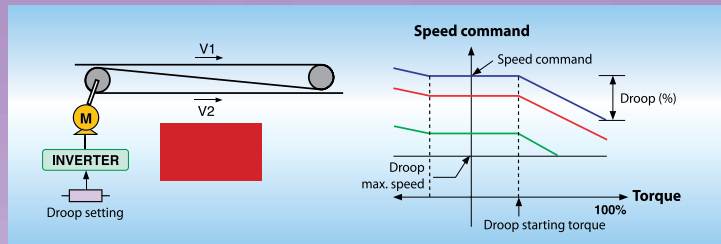

Built-in brake control for vertical loading safety

Brake Control

For applications which have a risk of dropping, for instance elevator and crane system, brake control is built in

Draw control

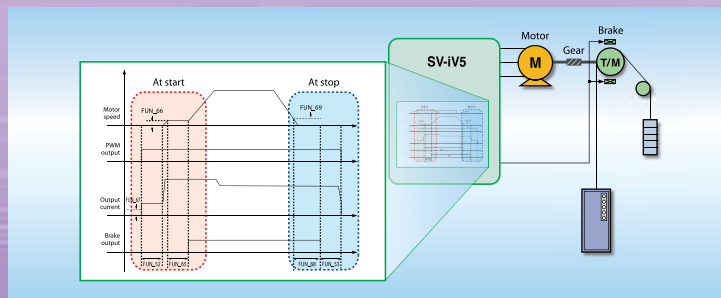

Extreme precise control

SIN/COS encoder option

With SIN/COS encoder option, users can control more precisely than normal encoder

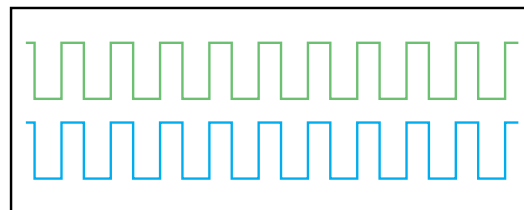
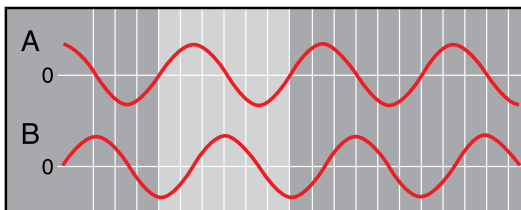

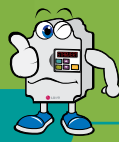

Features

User Friendly Interface

Easy to use with user-centric keypad and removable terminal blocks

A variety of communication supported such as LS485, Modbus-RTU, Device Net, Profibus-DP, CC-Link

Systematic and efficient management of system through DriveView



Convenience

Easy to maintain drive/motor parameter via PC

Drive View

Through DriveView program, drive system can be monitored with PC and managed to maintain drive/motor parameters.

- Window based Graphic User Interface (GUI)
- LS485, Modbus-RTU
- Max 31 drives connection
- Reporting
- Event logging
- Integrated control console
- Offline editing
- Data upload/download
- 4ch oscilloscope
- Trigger function

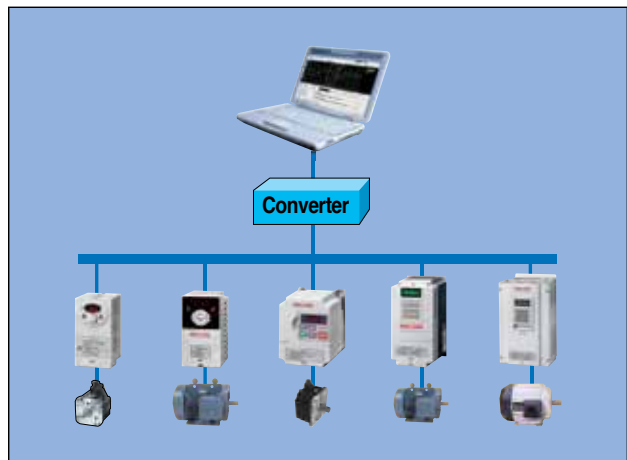



User friendly design



Easy-to-use keypad

By adopting a user-centered operation keypad, parameter setting becomes easier and when applying to system, a variety of required information can be monitored.



International standard removable terminal block

Wiring/maintenance become easy by international standard acquired terminal block and use also becomes easy by choosing various input/output options depending on intended use

Various fieldbus communication options

Providing a variety of fieldbus communication options such as LS485, Modbus-RTU, Device Net, Profibus-DP, CC-Link and so forth, users can monitor and operate drives connected with PLC, HMI and other controllers.



Drive View



Drive integrated console



Parameter management

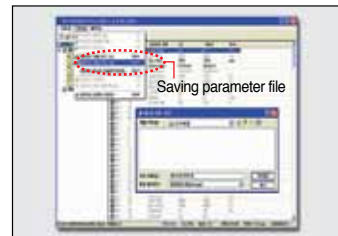

Reporting 1

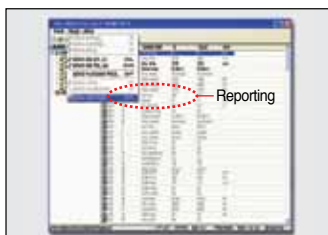

Reporting 2

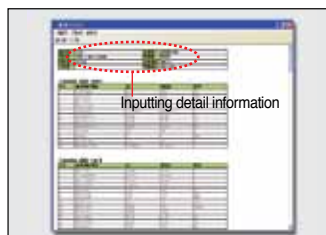

Oscilloscope/Trigger



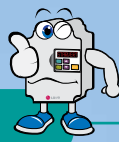

Features

Wider Applications with Various Options

Synchronous option, SIN/COS encoder option, expansion I/O, Elevator dedicated I/O and so forth

A wide range of options and applications

Variety

- Closed/Open loop continuous line control
- Load balance function
- Diameter operating /Taper function
- Splicing control /Inertia compensation
- Breakage detecting function
- Quick stop



- Closed/Open loop continuous line control
- Flux/Tension control with PID function
- Diameter operating /Taper function
- Splicing control /Inertia compensation
- Breakage detecting function
- Zero velocity control
- Quick stop



- Closed/Open loop continuous line control
- Flux/Tension control with PID function
- Diameter operating /Taper function
- Splicing control /Inertia compensation
- Breakage detecting function
- Jog operation at low speed
- Quick stop



- Built-in brake control
- Speed/Position synchronous operation
- Load balance function
- Dedicated DB unit

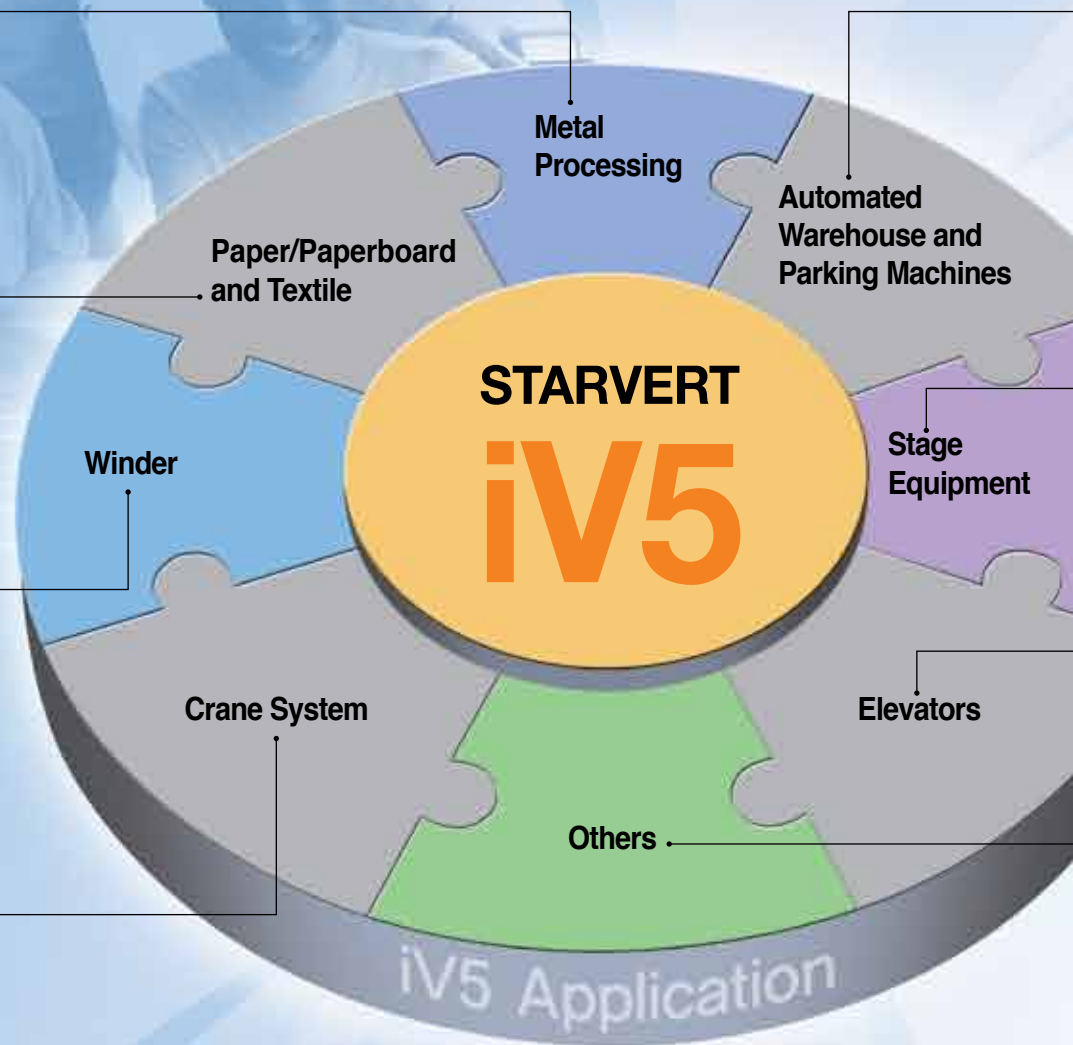

iV5 Option

■ Synchronization option

- Speed/Position synchronizing operation
- Consuming current : 300mA
- Input frequency : 100kHz
- Open collector output
- Multiple band operation



■ CC-Link

- Max. 10Mbps speed
- Customized LS profile
- CC Link customized cable
- Built-in termination resistor
- Remote I/O : each 32 point
- Remote register : 4 words



■ Elevator I/O

- Position sensor/Safety switch input
- Car position output
- E/L position and sequence control
- MC/Brake operation signal output
- E/L exclusive connector



■ LS485/Modbus-RTU

- 1200/2400/4800/9600/19200/38400 bps speed Bus, Multidrop link system
- Max. 31 node
- Max. 1200m period (recommended 700m)



■ Device Net

- 125/250/500kbps speed
- Bus topology
- Max. 64 node
- Max. 500m (125kbps)
- Enhanced online diagnosis function



■ Profibus-DP

- Max. 12Mbps speed
- Max. 32 station
- Bus topology
- Enhanced online diagnosis function



■ Extension I/O

- Analog input : 5 channel
- Analog output : 2 channel
- Other functions are same as SIO board



■ 24V Encoder I/O

- 24V encoder
- Encoder power fault detection
- Other specifications are same as SIO



■ SIN/COS + Endat encoder option

- Selectable Endat & Sin/Cos Option
- Max. 3,600rpm speed
- Enhanced Comfortable feeling in Car
 - Compatibility with Heidenhain Encoder
 - ECN413, ECN1313, ERN487, ERN1387



- Built-in brake control
- Load balance function
- Dedicated DB unit
- Zero velocity control
- Precise control through SIN/COS encoder

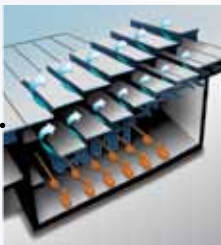

- Speed/Position synchronous operation
- Load balance function
- Precise control through SIN/COS encoder
- Zero velocity control
- Smooth acceleration and deceleration



- Elevator dedicated control mode
- Geared/gearless elevator operation
- Precise control through SIN/COS encoder
- Elevator master function with on-board option
- Optimum speed pattern / no creep speed
- Battery operation during blackout
- Load cell optimum compensation



- Machine tools / press
- Cart
- Hydraulic pump, high speed compressor, tower blower and so forth

*Note1) Please contact us to control continuous lines with open loop control

*Note1) For more than 4 analog inputs, users need to additionally purchase expansion I/O.

Model & Type

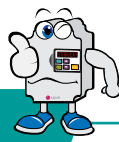

Applicable Motor ranges	200V Series	400V Series
2.2kW (3HP)	SV022iV5-2DB(MD)	SV022iV5-4DB(MD)
3.7kW (5HP)	SV037iV5-2DB(MD)	SV037iV5-4DB(MD)
5.5kW (7.5HP)	SV055iV5-2DB(MD)	SV055iV5-4DB(MD)
7.5kW (10HP)	SV075iV5-2DB(MD)	SV075iV5-4DB(MD)
11kW (15HP)	SV110iV5-2DB(MD)	SV110iV5-4DB(MD)
15kW (20HP)	SV150iV5-2DB(MD)	SV150iV5-4DB(MD)
18.5kW (25HP)	SV185iV5-2DB(MD)	SV185iV5-4DB(MD)
22kW (30HP)	SV220iV5-2DB(MD)	SV220iV5-4DB(MD)
30kW (40HP)	SV300iV5-2	SV300iV5-4
37kW (50HP)	SV370iV5-2	SV370iV5-4
45kW (60HP)		SV450iV5-4
55kW (75HP)		SV550iV5-4
75kW (100HP)		SV750iV5-4
90kW (120HP)		SV900iV5-4
110kW (150HP)		SV1100iV5-4
132kW (175HP)		SV1320iV5-4
160kW (215HP)		SV1600iV5-4
220kW (300HP)		SV2200iV5-4
280kW (375HP)		SV2800iV5-4
315kW (420HP)		SV3150iV5-4
375kW (500HP)		SV3750iV5-4
500kW (666HP)		SV5000iV5-4
800kW (1067HP)		SV8000iV5-4

■ Mold Type ■ Press Type

SV220iV-5 2DB

INPUT 200 - 230V 3phase
69A 50/60Hz

OUTPUT 0 - Input V 3phase
60A 0.1 - 400Hz
20HP/15kW

0010222100155

LS Industrial Systems Co., Ltd. Made in Korea

- Inverter type
- Input power specification
- Rated capacity
- Output power specification
- Operation frequency and rated output
- Bar-code
- Serial number

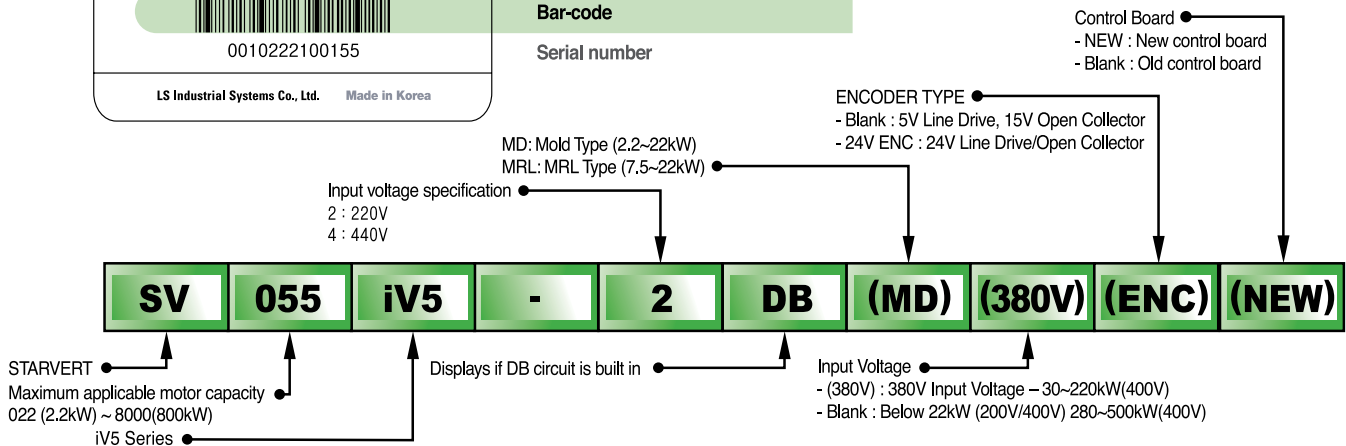

Standard Specification



■ 200V Class Specifications

Type : SV [] [] [] iV5-2(DB)		022	037	055	075	110	150	185	220	300	370
Maximum applicable motor ranges	[HP]	3	5	7.5	10	15	20	25	30	40	50
	[kW]	2.2	3.7	5.5	7.5	11	15	18.5	22	30	37
Rated output	Capacity [kVA] * Note2)	4.5	6.1	9.1	12.2	17.5	22.5	28.2	33.1	46	55
	Rated current [A]	12	16	24	32	46	59	74	88	122	146
	Output speed	0 ~ 3600 (rpm)									
	Output voltage	0 ~ 200V(230V) * Note3)									
Rated input	Voltage	3 ∅ 200 ~ 230V (-10% ~ +10%)									
	Frequency	50 ~ 60Hz (±5%)									
Weight [Kg(lbs)]		6	6	14	14	28	28	28	28	42	42

■ 400V Class Specifications

Type : SV [] [] [] iV5-4(DB)		022	037	055	075	110	150	185	220	300	370
Maximum applicable motor ranges	[HP]	3	5	7.5	10	15	20	25	30	40	50
	[kW]	2.2	3.7	5.5	7.5	11	15	18.5	22	30	37
Rated output	Capacity [kVA]	4.5	6.1	9.1	12.2	18.3	22.9	29.7	34.3	46	57
	Rated current [A]	6	8	12	16	24	30	39	45	61	75
	Output speed	0 ~ 3600 (rpm)									
	Output voltage	0 ~ 380V(480V) * Note3)									
Weight [Kg(lbs)]		6	6	14	14	28	28	28	28	42	42

Type : SV [] [] [] iV5-4(DB)		450	550	750	900	1100	1320	1600	2200	2800	3150	3750	5000	8000
Maximum applicable motor ranges	[HP]	60	75	100	120	150	175	215	300	373	420	500	666	1067
	[kW]	45	55	75	90	110	132	160	220	280	315	375	500	800
Rated output	Capacity [kVA]	70	85	116	140	170	200	250	329	416	468	557	732	1105
	Rated current [A]	91	110	152	183	223	264	325	432	546	614	731	960	1384
	Output speed	0 ~ 3600 (rpm)												
	Output voltage	380 ~ 460V * Note3)												
Rated input	Voltage	3 ∅ 380 ~ 460V (-10% ~ +10%) * Note4)												
	Frequency	50~60Hz (±5%)												
Weight [Kg(lbs)]		63	63	68	98	98	122	122	175	243	380	380	476	1300

*Note1) It represents the output capacity 05 maximum applicable motor in case LG-OTIS 4pole motor is used.

*Note2) Rated capacity (=√3VI) is calculated based on 220V for 200V class, 440V for 400V class.

*Note3) Maximum output voltage cannot be generated greater then specified input voltage.

*Note4) Derate the rated current by 10% when the input voltage is in the range above 480V.

*Note5) Rated current is derated by 10 % above 680 VDC of input voltage.



Standard Specifications

■ Mold type products' electric specifications are same as upper parts (2.2/3.7kW follow below table)

Type: SV [] [] [] iV5-2/4DB(MD)	055	075	110	150	185	220
Weight [Kg(lbs)]	7.7	7.7	13.7	13.7	20.3	20.3

■ 400V Class (DC power input type)

SV [] [] [] iV5-4DC		055	075	110	150	185	220	300	370	450	550
Maximum applicable	[HP]	7.5	10	15	20	25	30	40	50	60	75
motor ranges * Note1)	[kW]	5.5	7.5	11	15	18.5	22	30	37	45	55
output	Capacity [kVA] * Note2)	9.1	12.2	18.3	22.9	29.7	34.3	46	57	70	85
	Rated current [A]	12	16	24	30	39	45	61	75	91	110
	Speed	0 ~ 3600 (rpm)									
	Voltage	0 ~ 380V(480V) * Note3)									
Input rated Voltage					DC 540 ~ 680V(+10%) * Note5)						
Drive weight [Kg(lbs)]		12 (26)	12 (26)	24 (53)	24.5 (54)	25 (55)	25 (55)	38.5 (84)	38.5 (84)	50 (110)	50 (110)

SV [] [] [] iV5-4DC		750	900	1100	1320	1600	2200	2800	3150	3750	5000
Maximum applicable	[HP]	100	120	150	175	215	300	373	420	500	666
motor ranges * Note1)	[kW]	75	90	110	132	160	220	280	315	375	500
output	Capacity [kVA] * Note2)	116	140	170	200	250	329	416	468	557	732
	Rated current [A]	152	183	223	264	325	432	546	614	731	960
	Speed	0 ~ 3600 (rpm)									
	Voltage	0 ~ 380V(480V) * Note3)									
Input rated Voltage					DC 540 ~ 680V(+10%) * Note5)						
Drive weight [Kg(lbs)]		55 (121)	79 (174)	79 (174)	98.5 (217)	98.5 (217)	154.5 (340)	206 (454)	343 (756)	343 (756)	466 (1028)

■ 400V MRL Specifications

SV [] [] [] iV5-4(MRL)		075	110	150	220
Maximum applicable	[HP]	10	15	20	30
motor ranges	[kW]	7.5	11	15	22
Rated output	Capacity [kVA] * Note2)	13.7	20.6	27.5	39.6
	Rated current [A]	18	27	36	52
	Output speed	0~200 (rpm)			
	Output voltage	380~480V * Note3)			
Rated input	Voltage	3 ϕ 380 ~ 480V (-10% ~ +10%)			
	Frequency	50~60Hz (\pm 5%)			
Weight [Kg(lbs)]		14 (30.8)	14 (30.8)	18.7 (41)	19 (41.8)

*Note1) It represents the output capacity 05 maximum applicable motor in case LG-OTIS 4pole motor is used.

*Note2) Rated capacity (= $\sqrt{3}VI$) is calculated based on 220V for 200V class, 440V for 400V class.

*Note3) Maximum output voltage cannot be generated greater then specified input voltage.

*Note4) Derate the rated current by 10% when the input voltage is in the range above 480V.

*Note5) Rated current is derated by 10 % above 680 VDC of input voltage.

■ Common Specifications

Item		Specification
Circuit type		IGBT adopted voltage type drive
Control	Control type	Speed sensor use vector type control Open loop control: V/F control (90-220kW)
	Frequency / Speed control accuracy	Analog: $\pm 0.2\%$ of maximum command speed ($25 \pm 10^\circ\text{C}$) Digital: $\pm 0.01\%$ of maximum command speed ($0\sim 40^\circ\text{C}$)
	Frequency / Speed resolution	Analog: $\pm 0.05\%$ of maximum command speed Digital: 0.01% of maximum command speed
	Vector	Response speed torque control 50Hz 3%
	V / F	V / F pattern torque Boost Linear, Square, User V/F Manual torque boost(0-20%), Automatic torque boost
	Speed ACC/DEC	Time setup Combination Pattern 0.00-6000.0 sec (Time unit can be set) 4 combined of Acc/Dec eleration time Linear, S-Curve
Braking	Braking type Braking torque Braking resistor	Dynamic braking using external resistor 150% An external braking resistor is required
Input	Speed setting	Digital setting Multi-step-speed setup by digital input Analog input setting of -10~10V or 4~20mA Setting by options
	Analog input	3Channels (AI1, AI2, AI3) -10 ~ 10V, 4 ~ 20mA, 10 ~ 0V, 20 ~ 4mA, motor NTC (selectable) Selectable among 9 different multi-function analog inputs
	Digital input	FX, RX, BX, RST, P1 ~ P7 Multi function input terminal (P1~P7) can be selected among 27 functions.
Output	Analog output	2-Channel (AO1, AO2) -10 ~ 10V output Selective among 31 multi-function analog output functions
	Digital output	Multi function digital output: 2channels (1A-1B, 2A-2B) Fault digital output: 1channel (30A-30C, 30B-30C)
	Open collector output	1channel (OCI/EG)
Protection function		Over current, Over/Low voltage, Drive overheat, Drive thermal sensor open, Motor over heat, Motor thermal sensor open, Over speed, IGBT gate blocking (BX), Fuse open, Trip by unusual external signal, Encoder error, Communication error, Electronic thermal, Stall prevention (V/F), Over load(V/F), Drive over load
Environment	Installation environment	Indoor, free of corrosive gas and direct sunlight
	Ambient temperature	-10 ~ 40C (Non frozen condition)
	Ambient humidity	Below RH90% (Dew free)
	Cooling method	Forced cooling by FAN
	Altitude / Vibration	Below 1000 meters/ above sea level 5.9m/s^2 ($= 0.6\text{G}$)

Wiring



AC Input Type

2.2 ~ 22kW (200V/400V)(MD)

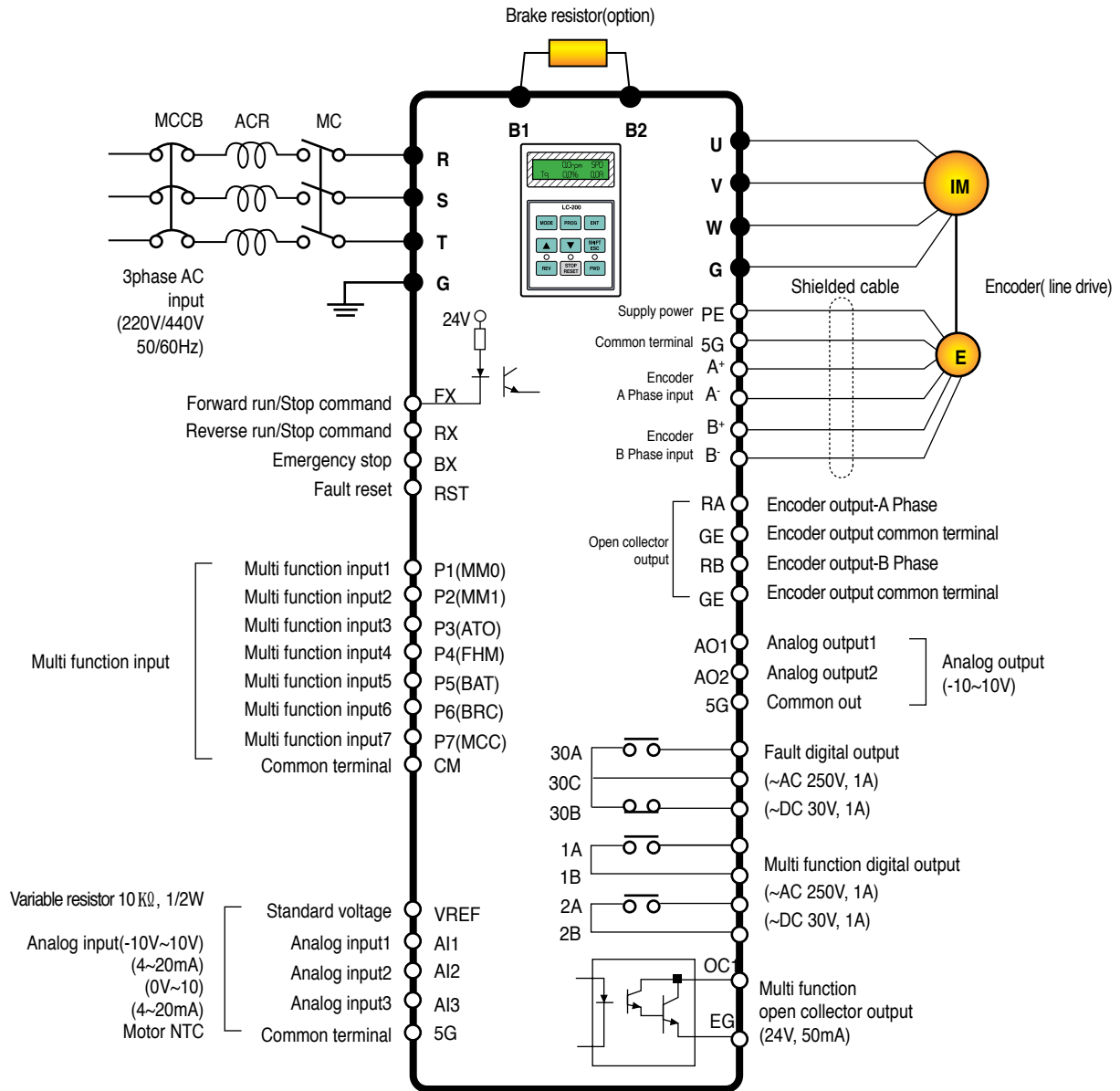

Note) ● : Power terminal ○ : control terminal

AC Input Type

30 ~ 37kW (200V)
30 ~ 375kW (400V)

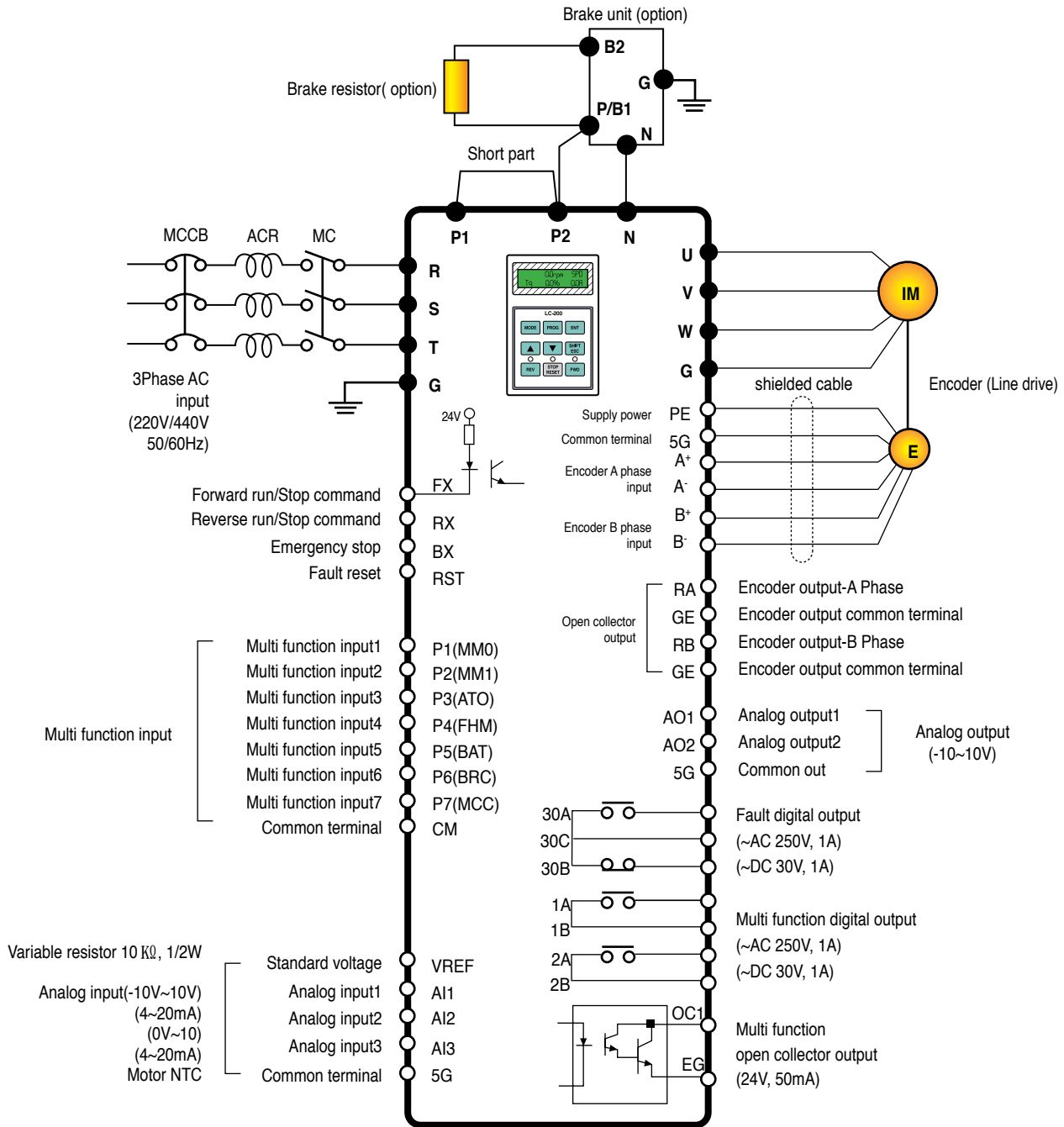

Wiring



AC Input Type

500kW / 800kW (400V)

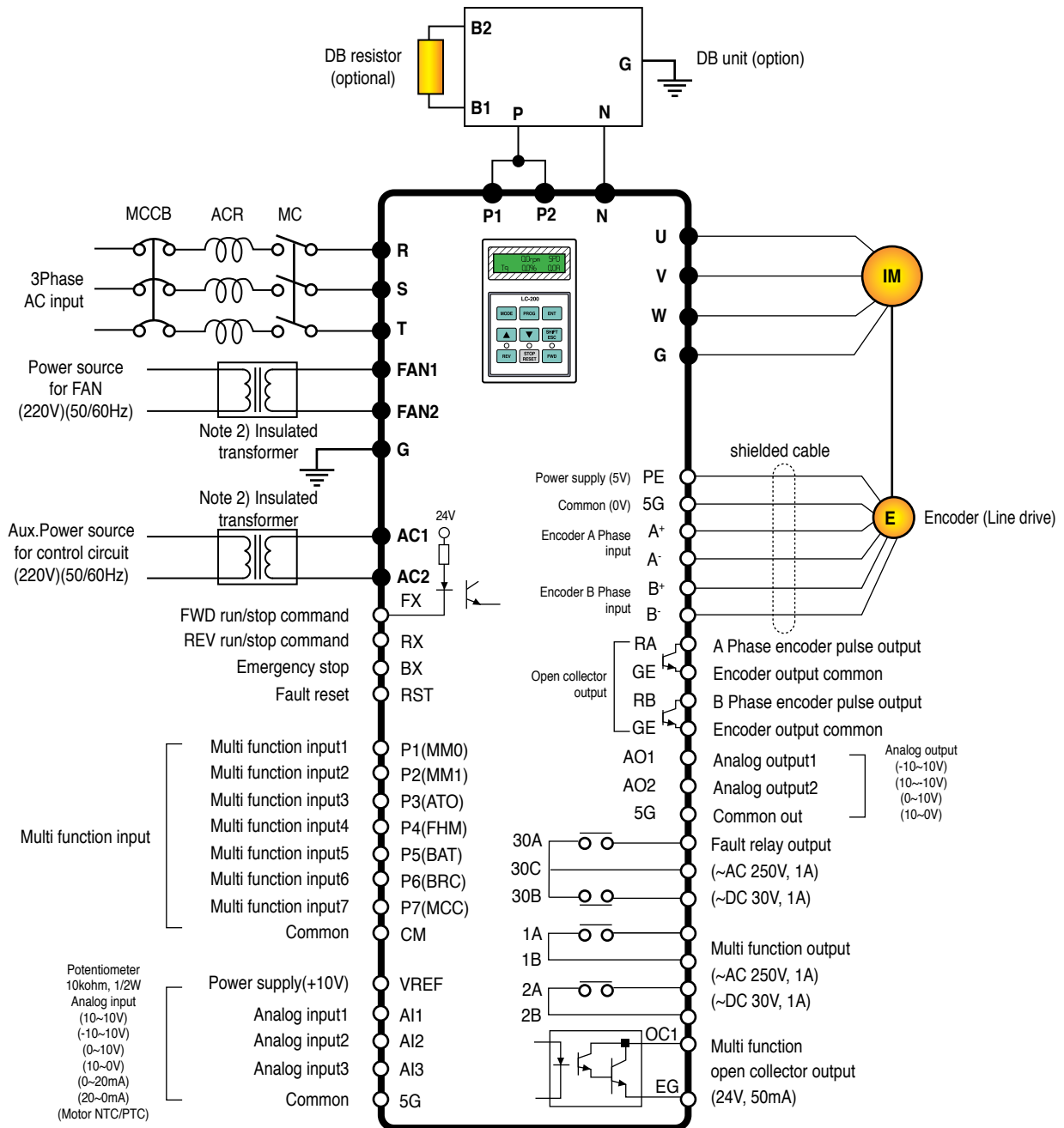

Note) ● : Power terminal ○ : control terminal

DC Input Type

5.5~375kW (400V)

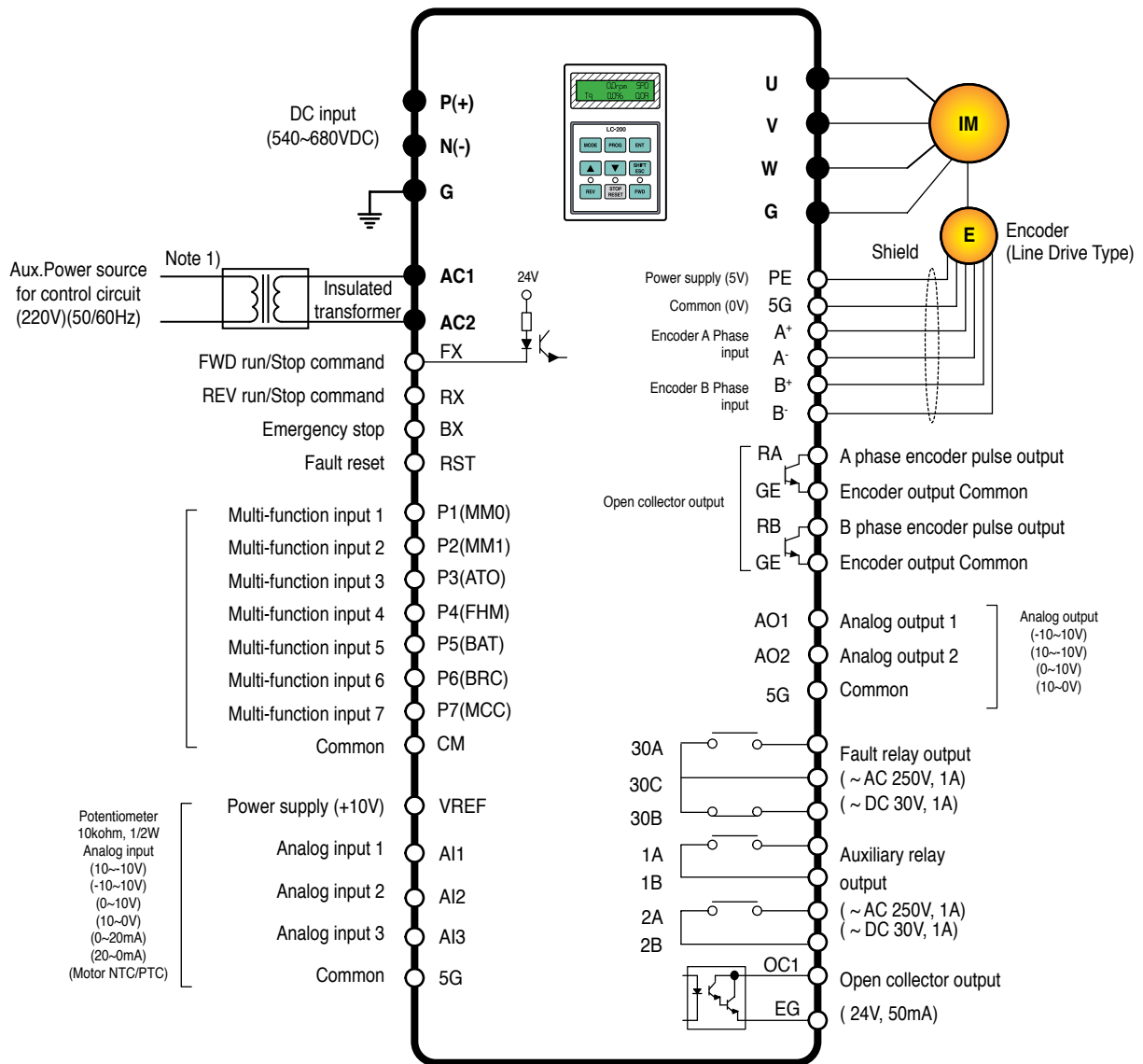

Note) ● : Power terminal ○ : control terminal

* SIO terminal indication for SV2800~3750iV5: PE → PENT, GE → G24X

Note 1) It is used when drive control circuit is energized from auxiliary power source (220 VAC) without main power supply. Use insulated transformer to separate from main power supply. (Transformer capacity: above 100VA recommended)

Wiring



DC Input Type

500kW (400V)



Warning) It must be energized AC220V (50/60Hz) to terminal of FAN1 and FAN2 because 30 ~ 500kW-4DC series have a cooling fan for AC power drive and MC. If not, Trip (30~160kW: "FAN/MC PWR", 220kW: "FAN PWR") will be occurred. The drive is not operated unless trip is released after AC220V inputs. The recommended order of power input and cutoff is as shown below.
(The order of power On: 220VAC → P(+)/N(-) → Run, The order of power Off: Stop → P(+)/N(-) → 220VAC)

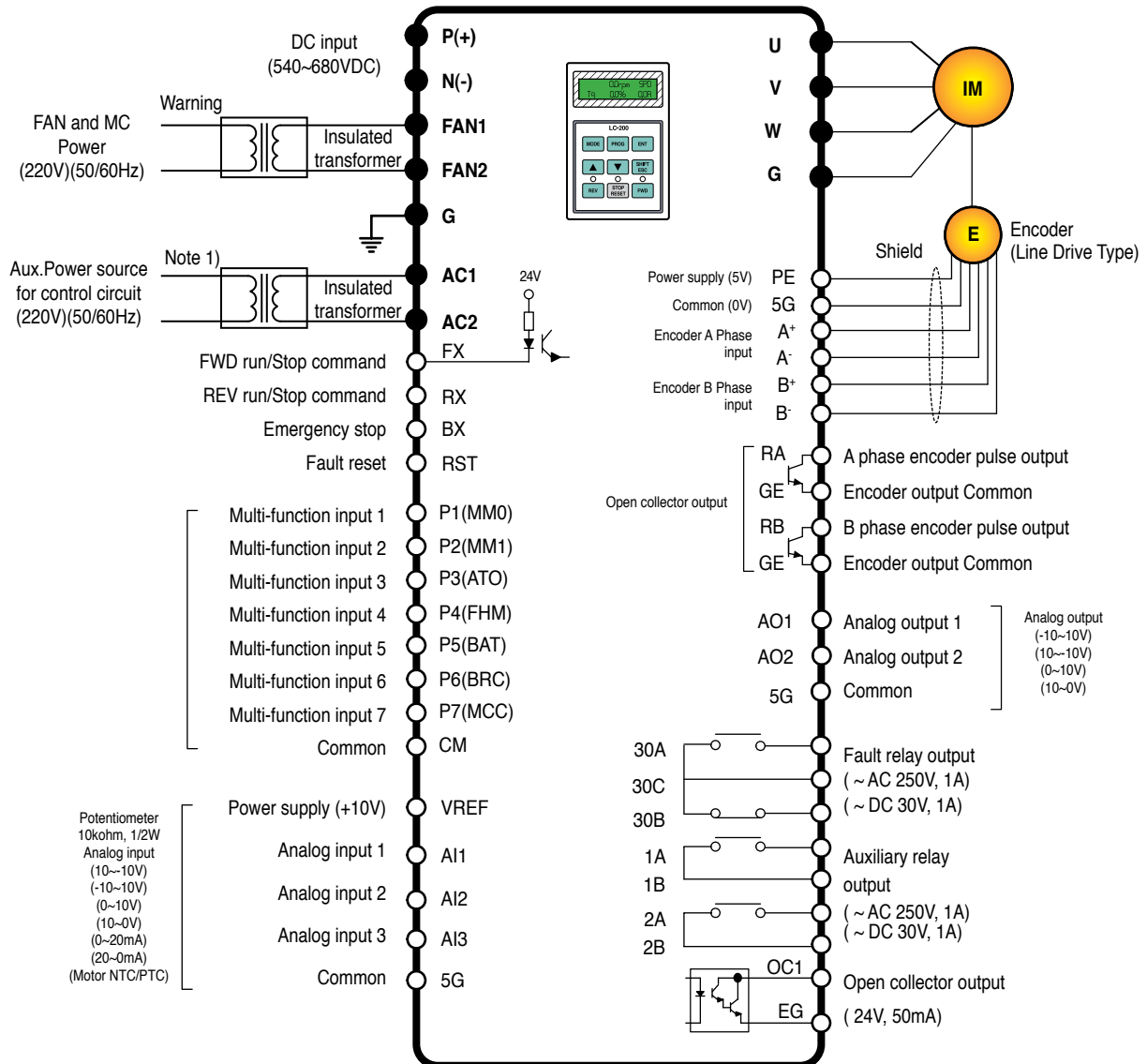

Note) ● : Power terminal ○ : control terminal

Note 1) It is used when drive control circuit is energized from auxiliary power source (220 VAC) without main power supply. Use insulated transformer to separate from main power supply. (Transformer capacity: above 100VA recommended)

7.5~22kW (MRL)

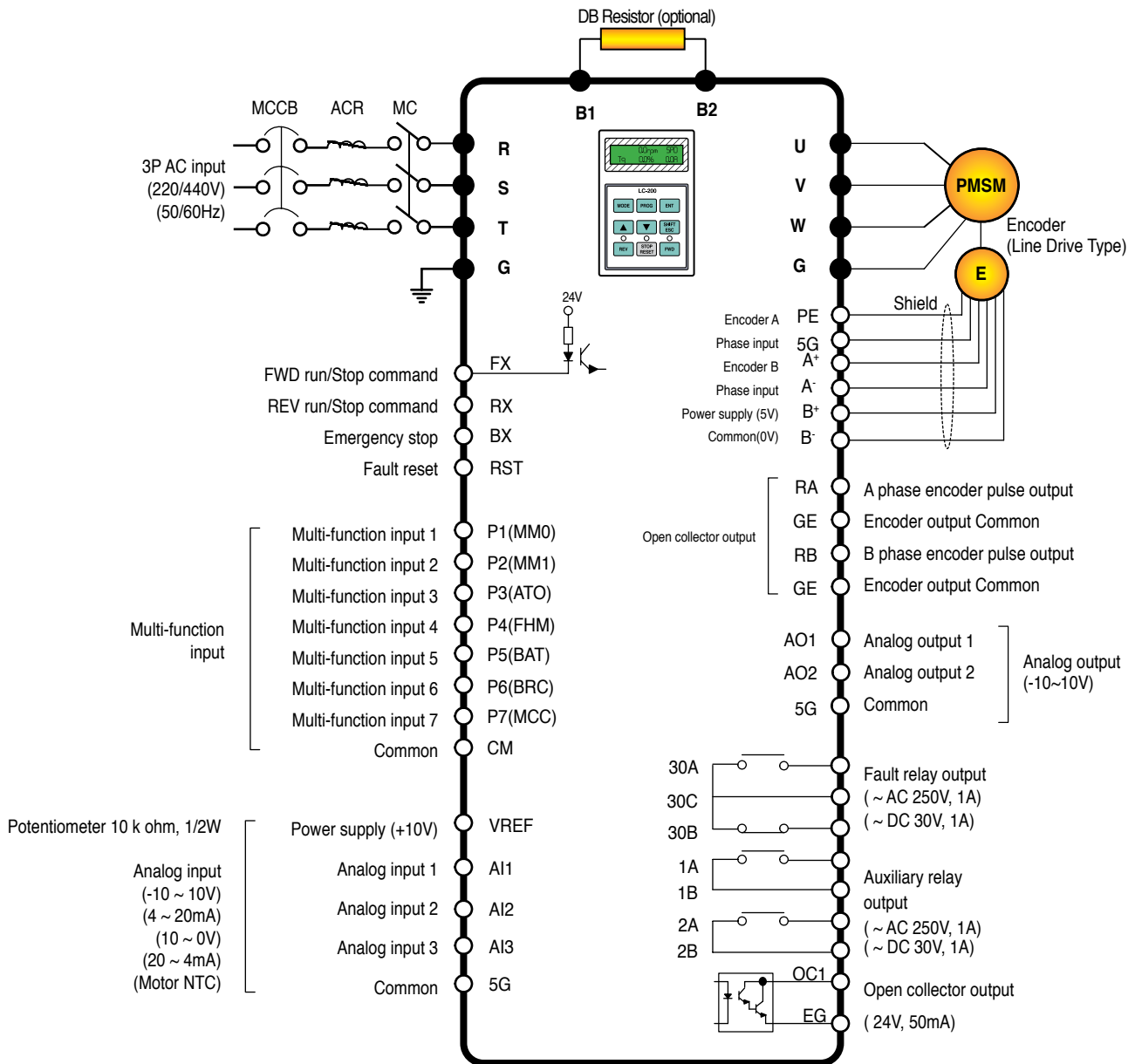

Note) ● : Power terminal ○ : control terminal



Terminal Function

■ Power Terminal

Display	Name	Description
R, S, T	AC Input	3Phase AC input connection 1) 200V: 200~230V, 50/60Hz 2) 400V: 300~460V, 50/60Hz
U, V, W	output	Cable connection of 3 phase induction motor
G	Earth	Drive frame earth terminal
B1, B2	Braking resistor	Braking resistor connection
P1, P2	DC reactor and Braking unit	DC reactor, braking unit and DC link common connection terminal
P	DC Link(+) terminal	DC Link common connection terminal
N	DC Link(-) terminal	Braking unit and DC link common terminal

■ Control Circuit Terminals

Item	Display	Name	Description
Digital input	FX RX RST P1(MMO)	Forward run command Reverse run command Fault reset	<ul style="list-style-type: none"> • "ON" when tied to CM terminal • Stops when FX and RX are ON/OFF simultaneously • Clears the fault condition only when the fault state is removed • Selectable among the following 27 functions: (Multi step speed selection 1/2/3, JOG run, MOP up/down/Save/Clear, Analog hold, Main drive, Second function, Speed Acc/Dec time selection, 3-wire operation, External default signal B contact point, Forward rotation prevention, Process PI disable, Timer input, Soft start cancellation, ASR PI Gain selection, ASR P.PI selection, Flux reference selection, Pre-excitation, Speed/Torque control selection, Torque limit use, Torque bias
	CM VREF	COMMON	<ul style="list-style-type: none"> • "ON" in case of connection between CM and digital
Analog input	A1 A2	Analog setting power voltage input Current input	<ul style="list-style-type: none"> • Variable resistor use standard voltage(+10V):10 KΩ • Voltage input(-10~10V), current input(4~20mA) • The motor NTC input is selectable • Selectable among following 9 functions; (Speed reference, Torque reference, Torque bias, Torque limit, Process PI control reference, Process PI controller feedback, Draw reference, Motor NTC input) • Jumper set up use AC voltage input → A11, A12: Open , A13:Left of switch
	A3	voltage input Motor NTC input	<ul style="list-style-type: none"> • Jumper set to use as voltage input → A11,A12: Short • With motor NTC(OTIS-LG Motor) input, switch direction setup → A13: Right of switch
	5G	COMMON	<ul style="list-style-type: none"> • Analog input COMMON terminal

■ Control Circuit Terminals

Classification	Display	Name	Description
Encoder Input	PE 5G	Encoder power	+5V Line drive power(Jumper set required) 0V
	A+ A-	Encoder A phase signal	<ul style="list-style-type: none"> • A and B phase signals of line drive encoder • To use the line drive type encoder, the "P5 pin" of I/O PCB JP2 should be shorted and then the JP1 switch should be pulled down to "LD" direction • Jumper setup (factory default)
	B+ B-	Encoder B phase signal	
	PE 5G	Encoder power	+15V Open collector power (Jumper setup is required) 0V
	PA PB	Encoder A phase signal Encoder B phase signal	<ul style="list-style-type: none"> • A and B phase signals of complementary and open collector type signals • Short the "P15 pin" of I/O PCB JP2 and then pull up the JP1 switch to "OC"
Encoder output	RA GE RB GE	Encoder output-phase A Encoder output common terminal Encoder output-phase B Encoder output common terminal	<ul style="list-style-type: none"> • Encoder phase A and B output signal (Open collector type)
	AO1	Analog output1	<ul style="list-style-type: none"> • Output -10V~+10V • Selection among following 31 items; (Motor speed, Speed reference1~2, Torque reference1~2, Torque current volume Flux reference, Flux reference volume, Drive output current, Drive output voltage, Motor temperature, DC voltage..)
	AO2	Analog output2	
	5G	COMMON	<ul style="list-style-type: none"> • COMMON terminal for analog output
Digital Output	1A 1B 2A 2B OC1 EG	Multi function digital output1(contact point A) Multi function digital output2(contact point B) Multi function open collector output	<ul style="list-style-type: none"> • Selectable among following 14 items; (Zero speed detection, speed detection(polarity valid), speed detection(rotation direction invalid), Speed reach, Speed matching, arbitrary torque detection Torque limit feature, Motor overheating signal, Drive overheating signal, Low voltage feature, Drive run signal, Drive regeneration signal, Drive run function, Timer output)
	30A	Fault signal A contact point	<ul style="list-style-type: none"> • Activates when the faults occur
	30B	Fault signal B contact point	<ul style="list-style-type: none"> • Not available in emergency stop
	30C	COMMON	<ul style="list-style-type: none"> • Common for A and B digital output

■ Control Circuit Terminal

Control Terminal Feature

- Control Terminal Panel Arrangement(Standard Type(SIO) - Non insulated type)

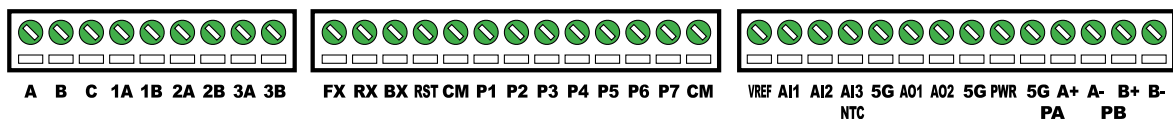

I/O Board

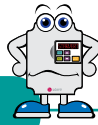

1) Encoder wiring and Jumper setup (+15V Complementary or Open collector)

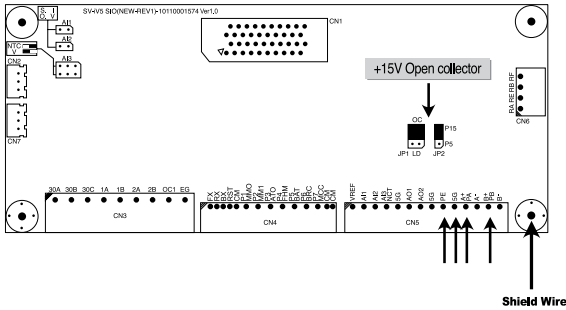

I/O PCB version : V1.0

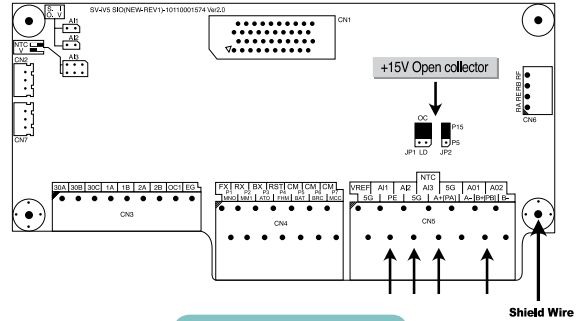

I/O PCB version : V2.0

2) Encoder wiring and Jumper setup (+5V Line drive)

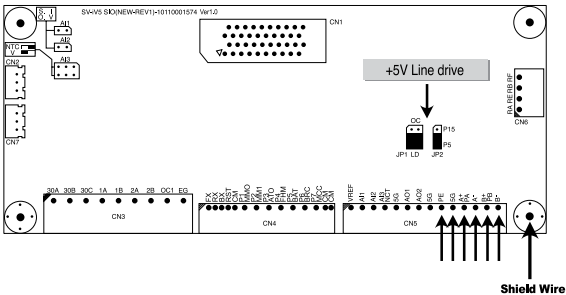

I/O PCB version : V1.0

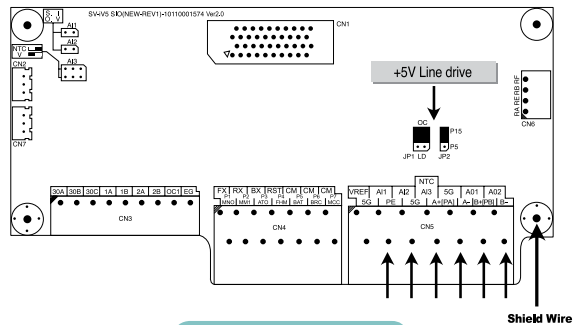

I/O PCB version : V2.0

3) Analog Input Jumper setup (Voltage/ Current/ Motor NTC inputs)

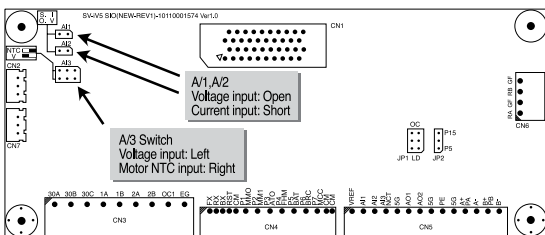

I/O PCB version : V1.0

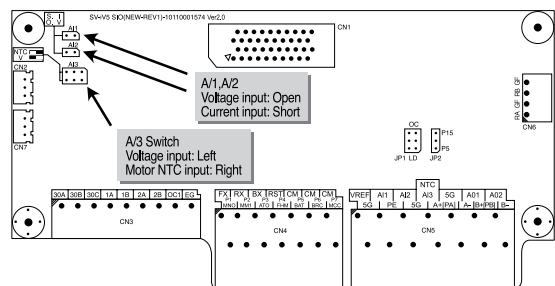

I/O PCB version : V2.0



Warning

- Do not change the jumper set for the encoder type during operation. The Jumper type change during operation results in a serious system damage. Jumpers should be set properly before the drive operation.
- The NTC input of the analog input 3(AI3) is only available with OTIS-LG motors. Use of different type of NTC may cause the motor damage due to overheating.



Loader Use

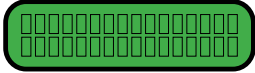

■ Data and status display



- Shift between function groups
- Shifting from group code to the upper code



- Function code shift
- Shift to next function code
- Data increase in set up mode



- Reverse run command key
- Only available, with loader operation
- LED is turned ON with reverse run
- Blinks during Acc/Deceleration of reverse run



- Shift to function code
- Shift to previous code
- Data is decreased in set up mode

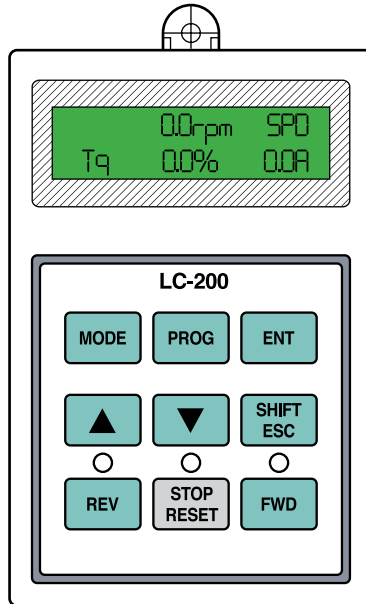

- Data set up start



- Data set up completion



- Decimal point shift
- Only available in case of data setup



- Forward run command key
- Only available with loader operation
- LED is turned on with forward operation
- Blinks during Acc/Deceleration of forward operation



- Stop command
- Available with the loader operation
- LED is turned on when drive stops its operation
- Blinks when fault occurs
- Reset
- Fault reset

Loader Use Instruction

Classification	Display	Function Name	Function
KEY	MODE	Mode Key	shift between groups. shift from a group code to upper code.
	PROG	Program Key	Parameter setting value change.
	ENT	Enter Key	Saving altered setting values.
	▲ (up)	Up Key	Shift between codes and increase the parameter value.
	▼ (down)	Down Key	Shift between codes and decrease the parameter value.
	Shift/ESC	Shift/ESC Key	In case of set up mode, it is operated with the shift key. Operation with ESC key in non-set up mode.
	REV	Reverse run	Reverse run key.
	STOP/RESET	Stop/Reset Key	Stop key when drive is on operation.
LED	(REV)	Reverse run key	Turns on at reverse operation. Blinks while the drive is on Acc/Deceleration and then turns on the constant speed operation.
	(STOP/RESET)	Stop/Fault display	Turns off when drive stops operation. Blinks when fault occurs.
	(FWD)	Forward Run Display	Turns on during forward operation. Acc/Deceleration running modes blink the lamp and it is turned on in the forward operation.



Shifts Between Each Groups and Codes in the Loader

■ Shifts between each groups and codes in LCD loader

The [MODE] key is used for transfer to the other group and the [▲UP] and the [▼down] keys are used to move up and down in the same group.

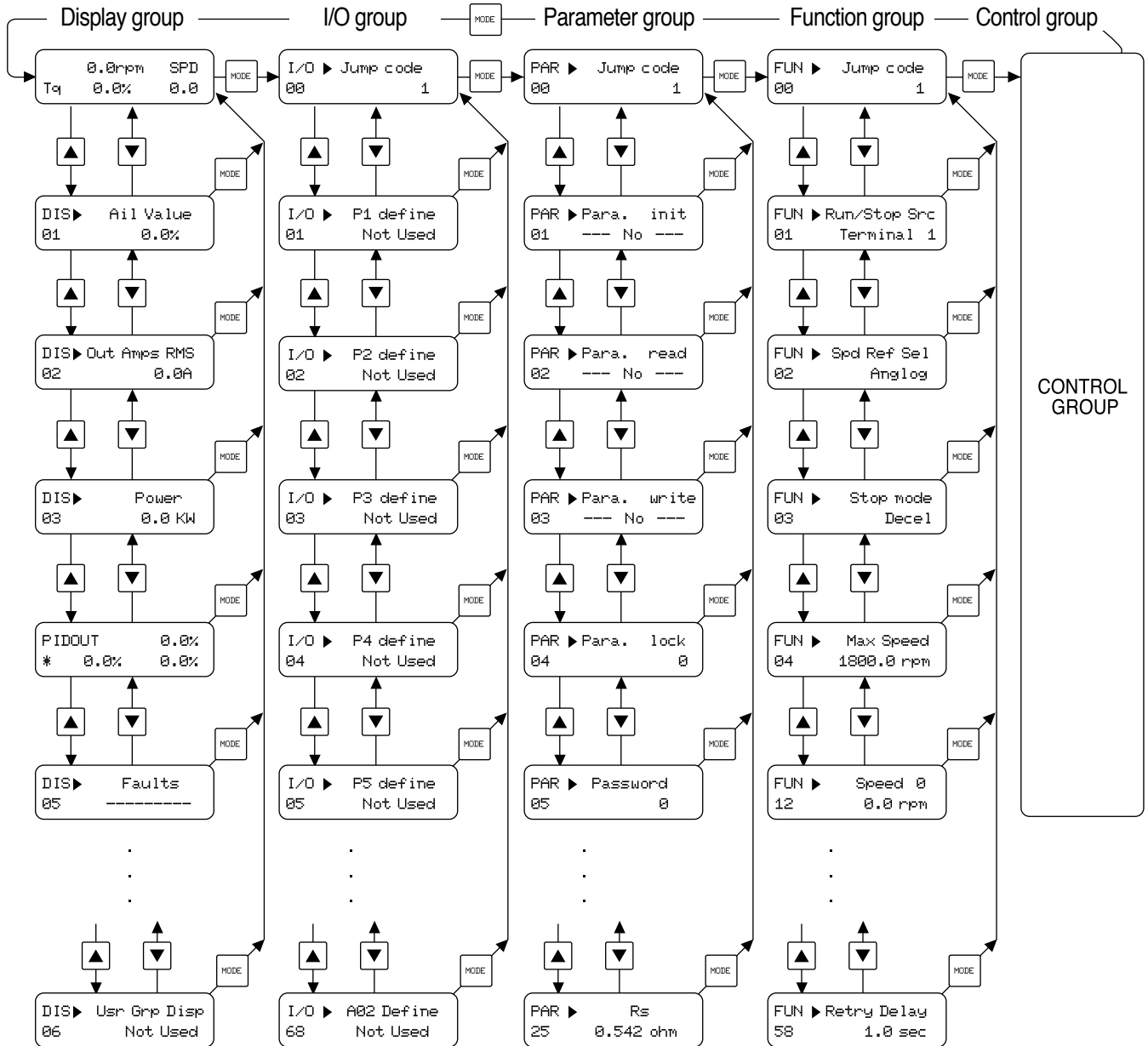

● The user group and the second group are omitted between shifts of each group.



Function Codes Table

* ‘ - ’ mark of communication address indicates communication exclusion.

* Setting during Drive operation (Yes : possible, No : impossible)

■ Display Group [DIS_ [] []]

Code No.	Comm. Addr	Code Name	LCD Display	Setting Data			Adjustment During Run ¹⁾
				Range	Unit	Default	
DIS_00	-	Motor Speed/Control Mode Output Torque/Output Current	0.0rpm Tq 0.0%		SPD 0.0A	-	-
DIS_01	-	User Display 1	Ai1 Value		%	PreRamp Ref	Yes
			Ai2 Value		%		
			Ai3 Value		%		
			Ai4 Value ¹⁾		%		
			Ai5 Value ¹⁾		%		
			PreRamp Ref		rpm		
			PostRamp Ref		rpm		
			ASR Inp Ref		rpm		
			Motor Speed		rpm		
			Motor SpdEst		rpm		
			Speed Dev		rpm		
			ASR Out		%		
			Torque Bias		%		
			PosTrq Limit		%		
			NegTrq Limit		- %		
			RegTrq Limit		%		
			Torque Ref		%		
			IqeRef		A		
			Iqe		A		
			Flux Ref		%		
			Ide Ref		A		
			Ide		A		
			ACR_Q Out		V		
			ACR_D Out		V		
			VdeRef		V		
			VqeRef		V		
			Out Amps RMS		A		
			Out Volt RMS		V		
			Power		kW		
			DC Bus Volt		V		
			Proc PI Ref		%		
			Proc PI F/B		%		
Proc PI Out		%					
MotTemp NTC		deg					
Inv Temp		deg					
Inv i2t		%					
MP Output		%					
Ctrl Mode		-					
S/W Version		-					
Run Time		-					
Terminal In		-					
Terminal Opt		-					
Terminal Out		-					
Run Status		-					
Diameter ²⁾		%					
Line SPD CMD ²⁾		%					
Reel SPD ²⁾		%					
PhInOpenLvl		V					
DIS_02	-	User Display 2	Same as the range of		-	DC Bus Volt	Yes
DIS_03	-	User Display 3	'DIS_01'		-	Terminal In	Yes
DIS_04	-	Process PID Output Ref / FB	PID Output *xx.x%		0.0% 0.0%	-	-
DIS_05	-	Faulty Display	Faults	-	-	-	-
DIS_06	7106	Display Setting	Disp	2 (Display ALL)		Used	Yes

*Note 1) It is effective only when you use Extended I/O (EXTN_I/O).

2) It is displayed on WEB control Mode.



Function Codes Table

■ Digital DIO Group [DIS_ [[]]]

Code No.	Comm. Addr	Code Name	LCD Display	Setting Data			Adjustment During Run	
				Range	Unit	Default		
DIO_00	-	Jump for quick view	Jump Code	1 ~ 98	-	-	Yes	
DIO_01	7201	Multi-function Input Terminal	P1 definition	P1 define	-	0 (Not Used)	No	
								0 (Not Used)
								1 (Speed-L)
								2 (Speed-M)
								3 (Speed-H)
								4 (Jog Speed)
								5 (MOP Up)
								6 (MOP Down)
								7 (MOP Clear)
								8 (MOP Save)
								9 (Analog Hold)
								10 (Main Drive)
								11 (2nd Func)
								12 (Xcel-L)
								13 (Xcel-H)
								14 (3-Wire)
								15 (Ext Trip-B)
								16 (Prohibit FWD)
								17 (Prohibit REV)
								18 (Proc PID Dis)
								19 (Timer Input)
								20 (SoftStrtCncl)
								21 (ASR Gain Sel)
								22 (ASR P/PI Sel)
								23 (Flux Ref Sel)
								24 (PreExcite)
								25 (Spd/Trq Sel)
								26 (Use Max Trq)
								27 (Use Trq Bias)
								28 (AuxSpdEnable)
								30 (Battery Run) ²⁾
								39 (Synch Disable) ³⁾
								40 (Synch Hod) ³⁾
								41 (LVT Disable)
								42 (Dia Hold) ¹⁾
								43 (Dia Preset) ¹⁾
								44 (CoreSize-L) ¹⁾
								45 (CoreSize-H) ¹⁾
								46(TensionDisable) ¹⁾
								47 (PI Gain Sel) ¹⁾
								48 (PID ITerm Clr) ¹⁾
								49 (Taper Disable) ¹⁾
								50 (Stall Enable) ¹⁾
								51 (Boost Enable) ¹⁾
								52 (Quick Stop) ¹⁾
								53 (Jog Web Fwd) ¹⁾
								54 (Jog Web Rev) ¹⁾
								55 (Under Wind) ¹⁾
								56 (Unwinder) ¹⁾

Code No.	Comm. Addr	Code Name	LCD Display	Setting Data			Adjustment During Run
				Range	Unit	Default	
DIO_02	7202	P2 definition	P2 define	Same as the range of 'DIO_1'	-	0 (Not Used)	No
DIO_03	7203	P3 definition	P3 define		-	0 (Not Used)	No
DIO_04	7204	P4 definition	P4 define		-	0 (Not Used)	No
DIO_05	7205	P5 definition	P5 define		-	0 (Not Used)	No
DIO_06	7206	P6 definition	P6 define		-	0 (Not Used)	No
DIO_07	7207	P7 definition	P7 define		-	0 (Not Used)	No
DIO_08	-	Negative function of multi-function input terminal	Neg Func. In		0000000 ~ 1111111	bit	0000000
DIO_09	7209	Multi-function Input LPF time constant	Terminal LPF	0 ~ 2000	-	5	Yes
DIO_10	-	Negative function of multi-function auxiliary output terminal	Neg Func. Out	00000~ 11111	bit	00000	No
DIO_41	7229	Definition of AX1	AX1 Define	0 (Not Used)	-	0 (Not Used)	Yes
				1 (INV Ready)			
				2 (Zero Spd Det)			
				3 (Spd Det.)			
				4 (Spd Det(ABS))			
				5 (Spd Arrival)			
				6 (Timer Out)			
				7 (LV Warn)			
				8 (Run)			
				9 (Regenerating)			
				10 (Mot OH Warn)			
				11 (Inv OH Warn)			
				12 (Spd Agree)			
				13 (Trq Det.)			
				14 (Trq Lmt Det.)			
				15 (OverLoad)			
				16 (Stop)			
17 (MC on/off)							
18 (Steady)							
19 (Brake Output)							
25 (WEB Break) ¹⁾							
26 (Up To Spd) ¹⁾							
27 (False Core) ¹⁾							
DIO_42	722A	Definition of AX2	AX2 Define	Same as the range of 'DIO_41'	-	0 (Not Used)	Yes
DIO_43	722B	Definition of OC1	OC1 Define		-	0 (Not Used)	Yes
DIO_46	722E	Fault relay mode selection	Relay Mode	000 ~ 111	bit	011	Yes



Function Codes Table

Code No.	Comm. Addr	Code Name	LCD Display	Setting Data			Adjustment During Run	
				Range	Unit	Default		
DIO_47	722F	Zero speed detection level	ZSD Level	0.0 ~ 480.0	rpm	10.0	Yes	
DIO_48	7230	Zero speed detection band	ZSD Band	0.1 ~ 10.0	%	0.5	Yes	
DIO_49	7231	Speed detection level	SD Level	-3600 ~ 3600	rpm	0	Yes	
DIO_50	7232	Speed detection band	SD Band	0.1 ~ 10.0	%	0.5	Yes	
DIO_51	7233	Speed arrival band	SA Band					
DIO_52	7234	Speed deviation band	SEQ Band					
DIO_53	7235	Torque detection level	TD Level	0.0 ~ 250.0	%	0.0	Yes	
DIO_54	7236	Torque detection band	TD Band	0.1 ~ 10.0	%	0.5	Yes	
DIO_55	7237	Timer On delay time	TimerOn Dly	0.1 ~ 3600.0	sec	0.1	Yes	
DIO_56	7238	Timer Off delay time	TimerOff Dly	0.1 ~ 3600.0	sec	0.1	Yes	
DIO_57	7239	Overload	Warning level	OL Level	30 ~ 250	%	150	Yes
DIO_58	723A		Warning time	OL Time	0 ~ 30	sec	10	Yes
DIO_59	723B		Trip selection	OLT Select	0 (No) / 1 (Yes)	-	1 (Yes)	Yes
DIO_60	723C		Trip level	OLT Level	30 ~ 250	%	180	Yes
DIO_61	723D		Trip time	OLT Time	0 ~ 60	sec	60	Yes
DIO_62	723E	warning temp.	Temp	50 ~ 85	deg	75	Yes	
DIO_63	723F	Drive overheat warning band	IH Warn Band	0 ~ 10	deg	5	Yes	
DIO_64	7240	Motor overheat warning temp.	MH Warn Temp	75 ~ 130	deg	120	Yes	
DIO_65	7241	Motor overheat warning band	MH Warn Band	0 ~ 10	deg	5	Yes	
DIO_67	7243	MC ON delay time ⁴⁾	MC Timer Off	100 ~ 50000	msec	1000	No	
DIO_68	7244	MC OFF delay time ⁴⁾	MC Timer Off	100 ~ 50000	msec	1000	No	
DIO_95	725F	Drive station address	Inv Number	1 ~ 250		1	No	
DIO_96	7260	485 BaudRate	485 BaudRate	0 (1200)	bps	9600	No	
				1 (2400)				
				2 (4800)				
				3 (9600)				
				4 (19200)				
5 (384000)								
DIO_97	7261	How to Run at Lost command	Lost Command	0 (None)	-	0 (None)	No	
				1 (FreeRun)				
				2 (Stop)				
DIO_98	7262	⁴⁾	Timer	10 ~ 300	sec	10	No	

*Note 1) Displayed WEB Control mode setting.

2) It can be set at 5.5 ~ 22 kW-2/4 class.

3) It will be displayed as CON_02 sets to 'Synchro' when Synchronization option board is installed.

4) It will be displayed when the definition of multi-funtion output sets as 'MC On/Off'.

5) It will be displayed RS-485 communication option board is installed. Refer to the user manual for RS485/Modbus-RTU option board (iP5A/iV5).

■ Parameter group [PAR_ [[]]]

Code No.	Comm. Addr	Code Name	LCD Display	Setting Data			Adjustment During Run	
				Range	Unit	Default		
PAR_00	-	Jump for quick view	Jump Code	1 ~ 38		-	-	Yes
PAR_01	7301	Initialize parameters	Para. init	0 (No)	0 (No)	-	0 (No)	No
				2 (DIS)	2 (DIS)			
				4 (PAR)	4 (PAR)			
				6 (CON)	6 (CON)			
				8 (AIO)	8 (AIO)			
				10 (2ND)	10 (2ND)			
				12 (SYN)	12 (SYN)			
			14 (SLS)	14 (SLS)				
PAR_02	-	Read parameters	Para. read	0(No) / 1(Yes)		-	0(No)	No
PAR_03	-	Write parameters	Para. write	0(No) / 1(Yes)		-	0(No)	No
PAR_04	-	Parameter write protection	Para. lock	0 ~ 255		-	0	Yes
PAR_04	-	Password	Password	0 ~ 9999		-	0	Yes
PAR_07	7307	Motor capacity selection	Motor select	0 (2.2)	1 (3.7)	kW	-	No
				2 (5.5)	3 (7.5)			
				4 (11.0)	5 (15.0)			
				6 (18.5)	7 (22.0)			
				8 (30.0)	9 (37.0)			
				10 (45.0)	11 (55.0)			
				12 (75.0)	13 (90.0)			
				14 (110.0)	15 (132.0)			
				16 (160.0)	17 (220.0)			
				18 (280.0)	19 (315.0)			
	20 (375.0)							
			21 (User Define ¹⁾)					
PAR_08	7308	Motor cap. selection of USER	UserMotorSel	0.7 ~ 500.0		kW	5.5	No
PAR_09	7309	Motor cooling type	Cooling Mtd	0 (Self-cool) 1 (Forced-cool)		-	1 (Forced cool)	Yes
PAR_10	730A	Pulse no.	Enc Pulse	360 ~ 4096		-	1024	No
PAR_11	730B	Direction setting	Enc Dir Set	0 (A Phase Lead) 1 (B Phase Lead)		-	0 (A Phase Lead)	No
PAR_12	730C	Error check enabling	Enc Err Chk	0 (No) / 1 (Yes)		-	1 (Yes)	No
PAR_13	730D	LPF time constant	Enc LPF	0 ~ 100		ms	1	Yes
PAR_14	730E	Error detection time	EncFaultTime	0.00 ~ 10.00		sec	0.00	No
PAR_15	730F	speed	EncFaultPerc	0.0 ~ 50.0		%	25.0	No
PAR_17	7311	Base speed	Base Speed	100.0 ~ 3600.0		rpm	1800.0	No
PAR_18	7312	Rated voltage	Rated Volt	120 ~ 560		V	-	No
PAR_19	7313	Number of poles	Pole number	2 ~ 12		-	4	Yes
PAR_20	7314	Efficiency	Efficiency	70.0 ~ 100.0		%	-	Yes
PAR_21	7315	Rated slip	Rated-Slip	10 ~ 250		rpm	-	Yes
PAR_22	7316	Rated current	Rated-Curr	1.0 ~ 1000.0		A	-	Yes
PAR_23	7317	Input power source selection	AC In Volt	170 ~ 230 320 ~ 480		V	-	No
PAR_24	7318	Auto tuning type selection ²⁾	Auto Tune Type	0 (Rotational) 1 (Standstill)		-	0 (Rotational)	



Function Codes Table

Code No.	Comm. Addr	Code Name	LCD Display	Setting Data			Adjustment During Run
				Range	Unit	Default	
PAR_25		Auto tuning range setting ²⁾	Auto Tuning	None ALL1/ALL2 Encoder Test Rs Tuning Lsigma Flux Curr Ls Tuning Tr Tuning Inertia Tuning ⁴⁾	-	None	No
PAR_26	731A	Tuning Torque	Tune Torque	10.0 ~ 100.0	%	70	Yes
PAR_27	731B	Motor flux current	Flux-Curr	70% to 0.0 ~ PAR_22	A	-	Yes
PAR_28	731C	Motor time constant	Tr	30 ~ 3000	ms	-	Yes
PAR_29	731D	Leakage inductance	Ls	0.00 ~ 500.00	mH	-	Yes
PAR_30	731E	Leakage coefficient	Lsigma	0.00 ~ 100.00	mH	-	Yes
PAR_31	731F	Stator resistance	Rs	0.000 ~ 5.000	ohm	-	Yes
PAR_34	7322	Encoder pulse multiplication ³⁾	Enc Scale	x1 / x16 / x32 / x64	-	x 1	No
PAR_35	7323	Selection for motor inertia tuning	Inertia Tune	0 (No) / 1 (Yes)	-	0 (No)	No
PAR_36	7324	Factor of motor inertia	Inertia	0.001 ~ 60.000	kg·m ²	-	Yes
PAR_37	7325	Acc./Dec. time of Inertia tuning	J Spd Time	0.500 ~ 10.000	sec	0.500	No
PAR_38	7326	Inertia LPF	Inertia LPF	0.010 ~ 50.000	ms	0.100	No

*Note 1) When PAR_07 is set to "User Define", PAR_08 will be displayed.

2) If PAR_24 (Auto-tuning type selection) is set to No.1 "Standstill", the order of display in PAR_25 (Auto-tuning range setting) will be None ⇒ ALL ⇒ Rs Tuning ⇒ Lsigma ⇒ If/Tr/Ls Tune.

3) Caution: PAR_33 (Enc Scale) Code is necessary only in the case of installation of SIN/COS Encoder option board, Don't modify the default value "X1" when not using SIN/COS Encoder board. If you modify the value, the normal operation isn't possible. For any extra information in detail, refer to the option dedicated manual.

4) It will be displayed when PAR_35(Selection for motor inertia tuning) sets as 'Yes'.

■ Function group [FUN_ [] []]

Code No.	Comm. Addr	Code Name	LCD Display	Setting Data			Adjustment During Run
				Range	Unit	Default	
FUN_00	-	Jump for quick view	Jump Code	1 ~ 85	-	-	Yes
FUN_01	7401	RUN/STOP command source selection	Run/Stop Src	0 (Terminal 1) 1 (Terminal 2) 2 (Keypad) 3 (Option)	-	0 (Terminal 1)	No
FUN_02	-	Speed setting source selection	Spd Ref Sel	0 (Analog) 1 (Keypad1) 2 (Keypad2) 3 (Option) 6 (Line SPD Ref) ¹⁾ 7 (Line SPD Opt) ¹⁾	-	1 (Keypad1)	No
FUN_03	7403	Stop mode selection	Stop mode	0 (Decel) 1 (Free-run)	-	0 (Decel)	No
FUN_04	7404	Max. motor speed	Max Speed	400.0 ~ 3600.0		1800.0	No
FUN_05	7405	Min. motor speed	Min Speed ²⁾	0.0 ~ 500.0		0.0	No
FUN_12	740C	Multi-step speed	0	0.0 ~ Max Speed	rpm	0.0	Yes
FUN_13	740D		1			0.0	Yes
FUN_14	740E		2			0.0	Yes
FUN_15	740F		3			0.0	Yes
FUN_16	7410		4			0.0	Yes
FUN_17	7411		5			0.0	Yes
FUN_18	7412		6			0.0	Yes
FUN_19	7413		7			0.0	Yes
FUN_20	7414		JOG speed			Jog Speed	
FUN_21	7415	Dwell Speed	Dwell Speed			100.0	No
FUN_22	7416	Dwell Time	Dwell Time	0.00 ~ 100.00	sec	0.00	No
FUN_33	7421	Acc./Dec. reference Speed	Acc/Dec Ref	0 (Max Speed) 1 (Ref Speed)		0 (Max Speed)	No
FUN_36	7424	S ratio 1 in acceleration start	Acc S Start	0.0 ~ 50.0	%	0.0	No
FUN_37	7425	S ratio 2 in acceleration start	Acc S End			0.0	No
FUN_38	7426	S ratio 1 in acceleration start	Dec S Start			0.0	No
FUN_39	7427	S ratio 2 in acceleration start	Dec S End			0.0	No
FUN_40	7428	Time scale of acc./dec. time	Time scale	0 (0.01 sec) 1 (0.1 sec)	-	0.0	No
FUN_41	7429	Acceleration time 1	Acc Time-1	0.00 ~ 6000.0	sec	2.00 ²⁾	Yes
FUN_42	742A	Deceleration time 1	Dec Time-1			2.00 ²⁾	Yes
FUN_43	742B	Acceleration time 2	Acc Time-2			3.00 ²⁾	Yes
FUN_44	742C	Deceleration time 2	Dec Time-2			3.00 ²⁾	Yes
FUN_45	742D	Acceleration time 3	Acc Time-3			4.00 ²⁾	Yes
FUN_46	742E	Deceleration time 3	Dec Time-3			4.00 ²⁾	Yes
FUN_47	742F	Acceleration time 4	Acc Time-4			5.00 ²⁾	Yes
FUN_48	7430	Deceleration time 4	Dec Time-4			5.00 ²⁾	Yes
FUN_49	7431	Selection about use of zero speed time	Use 0 Dec T	0 (No) / 1 (Yes)	-	0 (No)	Yes
FUN_51	7433	Dec.time of zero speed	0 Dec Time	0.00 ~ 6000.0	sec	0.00	Yes
FUN_52	7434	Dec. time of emergent stop	BX Time	0.0 ~ 6000.0	sec	0.0	Yes
FUN_53	7435	Initial excitation time of motor	PreExct Time	0 ~ 10000	ms	0	No



Function Codes Table

Code No.	Comm. Addr	Code Name	LCD Display	Setting Data			Adjustment During Run
				Range	Unit	Default	
FUN_54	7436	Hold time	Hold Time	100 ~ 10000	ms	1000	No
FUN_55	7437	Electronic thermal level for 1 minute	ETH Select	0 (No) / 1 (Yes)	-	0 (No)	Yes
FUN_56	7438	Electronic thermal level for continuous	ETH 1 min	FUN_56 ~ 200	%	150	Yes
FUN_33	7439	Switching frequency select	ETH Cont	50 ~ FUN_55 (Only available to 150%)	%	100	Yes
FUN_58	743A	selection	PWM Freq	2.5 ~ 10.0 ⁴⁾	kHz	to drive capacity	No
FUN_59	743B	Restart after fault reset	Power-on Run	0 (No) / 1 (Yes)	-	0 (No)	Yes
FUN_60	743C	Number of auto restart try	RST Restart	0 (No) / 1 (Yes)	-	0 (No)	Yes
FUN_61	743D	Delay time before Auto restart	Retry Number	0 ~ 10	-	0	Yes
FUN_62	743E	Wait time for Restart upon Stop	Retry Delay	0.0 ~ 60.0	sec	1.0	Yes
FUN_63	743F	Overspeed Detection Level	Restart Time ⁵⁾	0.00 ~ 10.00	sec	0.00	No
FUN_64	7440	Overspeed Detection Time	OverSpdLevel	100.0 ~ 130.0	%	120.0	No
FUN_65	7441	Electronic thermal level for 1 minute	OverSpd Time	0.00 ~ 2.00	sec	0.00	No
FUN_66	7442	Open Time ⁶⁾	BKOpen Time	0.00 ~ 30.00	sec	0.00	No
FUN_67	7443	Open Speed ⁶⁾	BKOpen Spd	0.0 ~ 500.0	rpm	0.0	No
FUN_68	7444	Open Current ⁶⁾	Release Curr	0.0 ~ 150.0	%	20.0	No
FUN_69	7445	Close Time ⁶⁾	BKClose Time	0.00 ~ 30.00	sec	0.00	No
FUN_70	7446	Close Speed ⁶⁾	BKClose Spd	0.0 ~ 500.0	rpm	0.0	No
FUN_71	7447	Run selection	RegenAvd Sel	0 (No) / 1 (Yes)	-	0 (No)	No
FUN_72	7448	Run voltage level ⁷⁾	RegenAvd Lvl	600(300) ~ 800(400)	V	700(350)	No
FUN_73	7449	Speed limitation ⁷⁾	CompFreq Lmt	0.0 ~ 500.0	rpm	100.0	No
FUN_74	744A	Speed P gain ⁷⁾	RegenAvd P	0.0 ~ 300.0	%	50.0	Yes
FUN_75	744B	Speed I gain ⁷⁾	RegenAvd I	20 ~ 30000	ms	500	Yes
FUN_76	744C	Speed in battery-operated mode ⁸⁾	Batt. Speed	2.5 ~ 200.0	rpm	50.0	No
FUN_77	744D	Battery input voltage ⁸⁾	Batt. Volt	12 ~ PAR_18	V	48	No
FUN_78	744E	Check of input phase-open	PhInOpenChk	0 (No) / 1 (Yes)	-	1 (Yes)	No
FUN_79	7450	Check level of input phase-open	PhInOpenLvl	2.0 ~ 100.0	V	3.0	Yes
FUN_80	7451	Check of output phase-open	PhOutOpenChk	0 (No) / 1 (Yes)	-	1 (Yes)	No
FUN_81	7452	Max. auxiliary speed	AuxSpeedMax	0.0~500.0	rpm	10.0	Yes
FUN_82	7453	Calculation method of auxiliary speed	AuxSpeedType	0 ~ 1	-	0	No
FUN_83	7454	Acc. time of auxiliary speed	AuxAccTime	0.00 ~ 600.00	sec	2.00	No
FUN_84	7455	Dec. time of auxiliary speed	AuxDecTime	0.00 ~ 600.00	sec	2.00	No
FUN_85	7456	Absolute/Relative mode for auxiliary speed	AuxSpeedMode	0(Absolute) 1(Relative)	-	0 (Absolute)	No

*Note 1) It will be displayed when WEB control mode is set.

2) It will be displayed when CON_01 is set to Sensorless.

3) A default value of a time of acceleration and deceleration is different from the setting capacity of drive.

4) Minimum/Maximum values are different from the capacity of drive.

5) It will be displayed when FUN_03 (Stop method) is set to 'Free-run'.

6) It will be displayed when the definition of DIO_41 to DIO_43 (Auxiliary output terminal of multi-function) is set to 'Brake Output'.

7) It will be displayed when FUN_71 is set to 'Yes'.

8) It can set for only 5.5 ~ 22 kW/2/4 products in case 'Battery Run' of multi-function input terminal (P1 ~ P&) is turned On.

■ Control group [CON_ [] []]

Code No.	Comm. Addr	Code Name	LCD Display	Setting Data			Adjustment During Run	
				Range	Unit	Default		
CON_00	-	Jump for quick view	Jump Code	1 ~ 80	-	-	Yes	
CON_01	7501	Control mode setting	Control Mode	1 (Speed) 2 (Torque) 3 (Sensorless)	-	1 (Speed)	No	
CON_02	-	Application mode setting	Application	General Vect Elevator 1) Synchro 2) WEB Control	-	General Vect	No	
CON_03	7503	ASR	P Gain 1	ASR P Gain1	0.1 ~ 200.0	%	50.0	Yes
CON_04	7504		I Gain 1	ASR I Gain1	0 ~ 50000	ms	300	Yes
CON_05	7505		LPF time constant 1	ASR LPF1	0 ~ 20000	ms	0	Yes
CON_06	7506		P Gain 2	ASR P Gain2	0.1 ~ 200.0	%	5.0	Yes
CON_07	7507		I Gain 2	ASR I Gain2	0 ~ 50000	ms	3000	Yes
CON_08	7508		LPF time constant 2	ASR LPF2	0 ~ 20000	ms	0	Yes
CON_09	7509		Ramp time for ASR gain	ASR RAMP	10 ~ 10000	ms	1000	Yes
CON_10	750A		Target Speed after ASR gain switch-over	ASR TarSpd	0.0 ~ 3600.0	rpm	0.0	No
CON_11	750B		Process ID	Reference (Loader)	Proc PID Ref	-100.0 ~ 100.0	%	0.0
CON_12	750C	Ramp time		PID Ramp	0.00 ~ 600.0	sec	0.00	No
CON_14	750E	P gain		Proc PID Kp	0.0 ~ 999.9	%	0.0	Yes
CON_15	750F	I gain		Proc PID Ki	0.0 ~ 100.0	%	0.0	Yes
CON_16	7510	D gain		PROC PID Kd	0.0 ~ 100.0	%	0.0	Yes
CON_17	7511	Positive limit		Proc Pos Lmt	-100.0 ~ 100.0	%	100	Yes
CON_18	7512	Negative limit		Proc Neg Lmt	-100.0 ~ 100.0	%	100	Yes
CON_19	7513	Output LPF time constant		Proc Out LPF	0 ~ 500	ms	0	Yes
CON_20	7514	Output gain		Proc OutGain	-250.0 ~ 250.0	%	0.0	Yes
CON_21	7515	Type selection		Proc PID Src	0 (Base Speed) 1 (Ref Speed) 2 (SpeedSet)		0 (Base Speed)	No
CON_22	7516	Speed Set setting 3)	PID SpeedSet	1.00 ~ FUN_04	rpm	100.0	No	
CON_23	7517	Output Enable	Proc PID Enb	0 (Disable) 1 (Enable) 2 (Terminal)	-	0 (Disable)	No	
CON_24	7518	Hold Time	PIDHoldTime	0 ~ 10000	ms	1000	No	
CON_25	7519	Draw quantity	Draw %	-100.0 ~ 100.0	%	0.0	Yes	
CON_26	751A	Droop	Control quantity	Droop %	0.0 ~ 100.0	%	0.0	Yes
CON_27	751B		Base speed	Droop Src	0(Base Spd)/ 1(Ref Spd)		1 (Ref Speed)	No
CON_28	751C		Ramp time	Droop Time	0.00 ~ 600.0	sec	2.00	Yes
CON_29	751D		Minimum speed	Droop MinSpd	0.0 ~ 3600.0	rpm	0.0	Yes
CON_30	751E		Minimum torque	Droop MinTrq	0.0 ~ 100.0	%	0.0	Yes
CON_31	751F	Torque	Reference source selection	Trq Ref Src	0 (None) 1 (Analog) 2 (Keypad) 3 (Option)	-	0 (None)	No
CON_32	7520		Reference (keypad)	Torque Ref	-180.0 ~ 180.0	%	0.0	Yes



Function Codes Table

Code No.	Comm. Addr	Code Name	LCD Display	Setting Data			Adjustment During Run
				Range	Unit	Default	
CON_33	7521	Limit source selection	Trq Lmt Src	0 (Kpd Kpd Kpd)	-	0 (Kpd Kpd Kpd)	No
	1 (Kpd Kpd Ax)						
	2 (Kpd Ax Kpd)						
	3 (Kpd Ax Ax)						
	4 (Ax Kpd Kpd)						
	5 (Ax Kpd Ax)						
	6 (Ax Ax Kpd)						
	7 (Ax Ax Ax)						
	8 (Opt Opt Opt)						
CON_34	7522	Limit in forward run	Pos Trq Lmt	0.0 ~ 250.0	%	150.0	Yes
CON_35	7523	Limit in reverse run	Neg Trq Lmt				
CON_36	7524	Limit in regeneration	Reg Trq Lmt				
CON_37	7525	Bias source selection	Trq Bias Src	0 (None)	-	0 (None)	No
	1 (Analog)						
	2 (Keypad)						
	3 (Option)						
CON_38	7526	Bias quantity	Trq Bias	-150.0 ~ 150.0	%	0.0	Yes
CON_39	7527	Bias feedforward	Trq Bias FF	-150.0 ~ 150.0	%	0.0	Yes
CON_40	7528	Balance quantity	Trq Balance	0.0 ~ 100.0	%	50.0	Yes
CON_54	7536	Speed Search selection	Speed Search	0000 ~ 1111 (Bit setting)	-	0100	No
CON_75	754B	Speed Search time ⁴⁾	SS Time	10 ~ 60000	ms	300	No
CON_76	754C	Speed Search P gain ⁴⁾	SS P Gain	1.0 ~ 300.0	%	100.0	Yes
CON_77	754D	Speed Search I gain ⁴⁾	SS I Gain	1.0 ~ 300.0	%	100.0	Yes
CON_78	754E	Speed Search LPF ⁴⁾	SS LPF	0.1 ~ 300.0	ms	33.3	Yes
CON_79	754F	Speed limit of Speed / Torque switch-over	Spd Lmt Src	0.1 ~ Max Speed	rpm	1800.0	No
CON_80	7550	Speed bias of speed / torque	SpdLmtBias	100.0 ~ Max Speed	rpm	100.0	No

*Note 1) It will be displayed only when the E/L_IO board is installed.

2) It will be displayed only when the SYNC_IO board is installed.

5) It will be displayed when CON_21 (Process PID type) is set to SpeedSet.

6) It will be displayed when CON_01 is set to Sensorless.

■ User group [USR_ [] []]

Code No.	Comm. Addr	Code Name	LCD Display	Setting Data			Adjustment During Run
				Range	Unit	Default	
USR_00	-	Select Code number	Jump Code	1 ~ 67	-	-	Yes
USR_01	-	Initialize to the initial value adequate to the application	Macro Init	User Define E/L	-	User Define	No
USR_02	-	User data save	User Save	No / Yes	-	No	No
USR_03	-	Recall saved User Data.	User Recall	No / Yes	-	No	No
USR_04	-	User Group Data	User Grp	-	-	-	No

■ Second motor Group [2nd_ [] []]

Code No.	Comm. Addr	Code Name	LCD Display	Setting Data			Adjustment During Run
				Range	Unit	Default	
2nd_00	-	Jump for quick view	Jump Code	1 ~ 37	-	-	Yes
2nd_01	7801	Control mode setting	2nd Ctl Mode	1 (Speed) 2 (Torque)	-	1 (Speed)	No
2nd_02	7802	Max. speed	2nd Max Spd	400.0 ~ 3600.0	rpm	1800.0	No
2nd_04	7804	Multi-step speed 0	2nd Spd 0	0.0 ~ 2nd_02	rpm	0.0	Yes
2nd_05	7805	S ratio 1 in acceleration start	2nd Acc S St	0.0 ~ 50.0	%	0.0	No
2nd_06	7806	S ratio 2 in acceleration end	2nd Acc S Ed				
2nd_07	7807	S ratio 1 in deceleration start	2nd Dec S St				
2nd_08	7808	S ratio 2 in deceleration end	2nd Dec S Ed				
2nd_09	7809	Acc./Dec. time scale	Time scale 2	0 (0.01 sec) 1 (0.1 sec)	-	0 (0.01 sec)	No
2nd_10	780A	Acceleration time	2nd Acc time	0.00 ~ 6000.0	sec	10.00	Yes
2nd_11	780B	Deceleration time	2nd Dec time				
2nd_12	780C	Cooling method	2nd Cool Mtd	0 (Self-cool) 1 (Forced-cool)	-	0 (Self-cool)	Yes
2nd_13	780D	Encoder pulse no.	2nd Enc #	360 ~ 4096	-	1024	No
2nd_14	780E	Encoder direction setting	2nd Enc Dir	0 (A Phase Lead) 1 (B Phase Lead)	-	0 (A Phase Lead)	No
2nd_15	780F	Encoder error check enable	2nd Enc chk	0 (No) 1 (Yes)	-	1 (Yes)	No
2nd_17	7811	Encoder LPF time constant	2nd Enc LPF	0 ~ 100	ms	1	Yes
2nd_18	7812	Base speed	2nd BaseSpd	300.0 ~ 3600.0	rpm	1800.0	No
2nd_19	7813	Capacity selection	Motor select	Refer to 'PAR_07'	kW	2 (5.5)	No
2nd_20	7814	User defined motor selection	UserMotorSel 1)	0.7 ~ 500	kW	5.5	No
2nd_21	7815	Rated voltage	2nd R-Volt	120 ~ 560	V	-	No
2nd_22	7816	Number of poles	2nd Pole #	2 ~ 12	-	4	No
2nd_23	7817	Efficiency	2nd Mot Eff.	70 ~ 100	%	-	Yes
2nd_24	7818	Rated slip	2nd R-Slip	10 ~ 250	rpm	-	Yes
2nd_25	7819	Rated current	2nd R-Curr	1.0 ~ 450.0	A	-	Yes
2nd_26	781A	Flux current	2nd Flx Cur	0.0 ~ 70% of 2nd_22	A	-	Yes
2nd_27	781B	Motor time constant	2nd Mot Tr	30 ~ 3000	ms	-	Yes
2nd_28	781C	Leakage inductance	2nd Mot Ls	0.00 ~ 500.00	mH	-	Yes
2nd_29	781D	Leakage coefficient	2nd Mot sLs	0.00 ~ 100.00	mH	-	Yes
2nd_30	781E	Stator resistance	2nd Mot Rs	0.000 ~ 5.000	ohm	-	Yes
2nd_35	7823	Electronic thermal level for 1 minute 1)	2nd ETH 1min	100 ~ 150	%	150	Yes
2nd_36	7824	Electronic thermal continuous level 1)	2nd ETH cont	50 ~ 150	%	100	Yes
2nd_37	7825	Inertia coefficient	Inertia	0.001 ~ 60.000	kg·m ²	0.072	Yes

*Note 1) It will be displayed when FUN_55 ETH Select is set to 'Yes'.



Function Codes Table

■ Option Group [EXT_ [[]]]

Code No.	Comm. Addr	Code Name	LCD Display	Setting Data			Adjustment During Run
				Range	Unit	Default	
EXT_00	-	Function code selection	Jump Code	1 ~ 99	-	-	Yes
EXT_01	7601	Mounted option board type	Opt B/D	0 (None) 1 (DeviceNet) 2 (Synchro) 3 (PLC-GF) 4 (PROFIBUS) 6 (RS485) 1) 7 (MODBUS)	-	0 (None)	No
EXT_02	7602	Mounted option board version	Opt Version	1.0 ~	Ver --		No
EXT_03	7603	Station address for the communication with PLC	Station ID ²⁾	0 ~ 63	-	1	Yes
EXT_04	7604	DeviceNet baud rate	Baud Rate ³⁾	0 (125)/1 (250)/2 (500)	kbps	0 (125)	-
EXT_05	7605	DeviceNet MAC ID	MAC ID ³⁾	0 ~ 63	-	63	-
EXT_06	7606	Read object setting for DeviceNet	Out Instance ³⁾	0 (20)/ 1 (21) 2 (100)/ 3 (101)	-	0 (20)	-
EXT_07	7607	Write object settinf for DeviceNet	In Instance ³⁾	0 (70)/ 1 (71) 2 (110)/ 3 (111)	-	0 (70)	-
EXT_09	7609	Profibus MAC ID	Profi MAC ID	1 ~ 127	-	1	Yes
EXT_10	760A	Number of option output	Output Num	0 ~ 8 ⁵⁾	-	3	Yes
EXT_11	760B	Option output 1	Output 1 ⁵⁾	0000 ~ FFFF	HEX	0020	Yes
EXT_12	760C	Option output 2	Output 2 ⁵⁾	0000 ~ FFFF	HEX	000E	Yes
EXT_13	760D	Option output 3	Output 3 ⁵⁾	0000 ~ FFFF	HEX	000F	Yes
EXT_14	760E	Option output 4	Output 4 ⁵⁾	0000 ~ FFFF	HEX	000A	Yes
EXT_15	760F	Option output 5	Output 5 ⁵⁾	0000 ~ FFFF	HEX	0000	Yes
EXT_16	7610	Option output 6	Output 6 ⁵⁾	0000 ~ FFFF	HEX	0000	Yes
EXT_17	7611	Option output 7	Output 7 ⁵⁾	0000 ~ FFFF	HEX	0000	Yes
EXT_18	7612	Option output 8	Output 8 ⁵⁾	0000 ~ FFFF	HEX	0000	Yes
EXT_19	7613	Number of option input	Input Num	0 ~ 8 ⁶⁾	-	2	Yes
EXT_20	7614	Option input 1	Input 1 ⁶⁾	0000 ~ FFFF	HEX	0502	No
EXT_21	7615	Option input 2	Input 2 ⁶⁾	0000 ~ FFFF	HEX	0500	No
EXT_22	7616	Option input 3	Input 3 ⁶⁾	0000 ~ FFFF	HEX	0000	No
EXT_23	7617	Option input 4	Input 4 ⁶⁾	0000 ~ FFFF	HEX	0000	No
EXT_24	7618	Option input 5	Input 5 ⁶⁾	0000 ~ FFFF	HEX	0000	No
EXT_25	7619	Option input 6	Input 6 ⁶⁾	0000 ~ FFFF	HEX	0000	No
EXT_26	761A	Option input 7	Input 7 ⁶⁾	0000 ~ FFFF	HEX	0000	No
EXT_27	761B	Option input 8	Input 8 ⁶⁾	0000 ~ FFFF	HEX	0000	No
EXT_30	761E	485 communication mode	Parity/Stop ¹⁾	0 (8None/1Stop) 1 (8None/2Stop) 2 (8Even/1Stop) 3 (8Odd/1Stop)	-	0 (8None/1Stop)	Yes
EXT_31	761F	Delay time of 485 communication response	Delay Time ¹⁾	2 ~ 1000	ms	5 2	Yes Yes
EXT_32	7620	Station address for built-in 485	Int485 St ID	1 ~ 250	-		Yes
EXT_33	7621	Built-in 485 baudrate	Int485 Baud	0 (1200 bps) 1 (2400 bps) 2 (4800 bps) 3 (9600 bps) 4 (19200 bps) 5 (38400 bps)	-	3 (9600 bps)	Yes

Code No.	Comm. Addr	Code Name	LCD Display	Setting Data			Adjustment During Run
				Range	Unit	Default	
EXT_34	7622	Built-in 485 communication mode	Int485 Mode	0 (8None/1Stop) 1 (8None/2Stop) 2 (8Even/1Stop) 3 (8Odd/1Stop)	-	-	Yes
EXT_35	7623	Delay time for built-in 485 communication response	Int485 Delay	2 ~ 1000	-	0 (None)	Yes
EXT_36	7624	Run method when the command of built-in 485 is lost.	Int485 LostC	0 (None) 1 (FreeRun) 2 (Stop)	-	-	Yes
EXT_37	7625	Decision time for losing the command of built-in 485	Int485 LostT	1.0 ~ 30.0	-	-	Yes
EXT_99	7663	Decision time for losing the command of built-in 485	Comm UpDate ⁴⁾	0 (No) / 1 (Yes)	-	0 (No)	No

- *Note
- 1) It will be displayed when RS-485 communication option board is installed.
 - 2) It will be displayed when PLC-GF communication option board is installed.
 - 3) It will be displayed when DeviceNet communication option board is installed.
 - 4) It will be displayed when Profibus communication option board is installed.
 - 5) From EXT_11 to EXT_18 (Option output) are displayed according to the number from EXT_11.
 - 6) From EXT_20 to EXT_27 (Option input) are displayed according to the number from EXT_19.
 - 7) Refer to the appropriate option manual.



Function Codes Table

■ Analog AIO Group [AIO_ [[]]]

Code No.	Comm. Addr	Code Name	LCD Display	Setting Data			Adjustment During Run
				Range	Unit	Default	
AIO_00	-	Select code number	Jump Code	1 ~ 83	-	-	Yes
AIO_01	7701	Multi-function Analog input Ai1 definition	Ai1 Define	00 (Not Used)	-	0 (Not Used)	No
				01 (Speed Ref)			
				02 (Proc PID Ref)			
				03 (Proc PID F/B)			
				04 (Draw Ref)			
				05 (Torque Ref)			
				06 (Flux Ref)			
				07 (Torque Bias)			
				08 (Torque Limit)			
				09 (Line SPD Ref) ¹⁾			
				10 (Tension Ref) ¹⁾			
				11 (Dancer Ref) ¹⁾			
				12 (Taper Ref) ¹⁾			
				13 (Tension F/B) ¹⁾			
				14 (Diameter) ¹⁾			
		15 (Diam Preset) ¹⁾					
AIO_02	7702	Source definition	Ai1 Source	0 (-10 ⇒ 10V) 1 (10 ⇒ -10V) 2 (0 ⇒ 10V) 3 (10 ⇒ 0V) 4 (0 ⇒ 20mA) 5 (20 ⇒ 0mA)	-	0 (Not Used)	No
AIO_03	7703	Minimum Voltage	Ai1 In X1	0.00 ~ Ai1 In X2	%	0.00	Yes
AIO_04	7704	Minimum Voltage Bias	Ai1 Out Y1	-10.00 ~ Ai1 Out Y2	%	0.00	Yes
AIO_05	7705	Maximum Voltage	Ai1 In X2	0.00 ~ 100.00	%	100.00	Yes
AIO_06	7706	Maximum Voltage Gain	Ai1 Out Y2	0.00 ~ 250.00	%	100.00	Yes
AIO_07	7707	Minimum Voltage	Ai1 -In X1	Ai1 -In X2 ~ 0.00	%	0.00	Yes
AIO_08	7708	Minimum Voltage Bias	Ai1 -Out Y1	Ai1 -Out Y2 ~ 10.00	%	10.00	Yes
AIO_09	7709	Maximum Voltage	Ai1 -In X2	-100.00 ~ 0.00	%	-100.00	Yes
AIO_10	770A	Maximum Voltage Gain	Ai1 -Out Y2	-250.00 ~ 0.00	%	-100.00	Yes
AIO_11	770B	LPF time constant	Ai1 LPF	0 ~ 2000	ms	-	
AIO_12	770C	Command loss Criterion select	Ai1 Wbroken	0 (None) 1 (Half of x1) 2 (Below x1)	-	0 (None)	No
AIO_13	770D	Multi-function Analog input Ai2 Definition	Ai2 Define	Refer to AIO_01~12			
AIO_14	770E	Source definition	Ai2 Source				
AIO_15	770F	Minimum Voltage	Ai2 In X1				
AIO_16	7710	Minimum Voltage Bias	Ai2 Out Y1				
AIO_17	7711	Maximum Voltage	Ai2 In X2				
AIO_18	7712	Maximum Voltage Gain	Ai2 Out Y2				
AIO_19	7713	Minimum Voltage	Ai2 -In X1				
AIO_20	7714	Minimum Voltage Bias	Ai2 -Out Y1				
AIO_21	7715	Maximum Voltage	Ai2 -In X2				
AIO_22	7716	Maximum Voltage Gain	Ai2 -Out Y2				
AIO_23	7717	LPF time constant	Ai2 LPF				
AIO_24	7718	Loss command Criterion select	Ai2 Wbroken				

*Note 1) Displayed only when WEB mode setting

Code No.	Comm. Addr	Code Name	LCD Display	Setting Data			Adjustment During Run	
				Range	Unit	Default		
AIO_25	7719	Multi-function Analog Input Ai3	Multi-function Analog input Ai3 Definition	Ai3 Define	Refer to AIO_01 ∫ Possible to select NTC motor 17 (Use Mot NTC)	0 (Not Used)	No	
AIO_26	771A		Source Definition	Ai3 Source	0 (-10 ⇒ 10V)	-	0 (-10 ⇒ 10V)	No
					1 (10 ⇒ -10V)			
					2 (0 ⇒ 10V)			
					3 (10 ⇒ 0V)			
AIO_27	771B		Minimum Voltage	Ai3 In X1	Refer to AIO_03~12			
AIO_28	771C		Minimum Voltage Bias	Ai3 Out Y1				
AIO_29	771D		Maximum Voltage	Ai3 In X2				
AIO_30	771E		Maximum Voltage Gain	Ai3 Out Y2				
AIO_31	771F		Minimum Voltage	Ai3 -In X1				
AIO_32	7720		Minimum Voltage Bias	Ai3 -Out Y1				
AIO_33	7721		Maximum Voltage	Ai3 -In X2				
AIO_34	7722		Maximum Voltage Gain	Ai3-Out Y2				
AIO_34	7723	Input LPF time constant	Ai3 LPF					
AIO_36	7724	Multi-function Analog input Command loss criterion select	Ai3 Wbroken					
AIO_37		Multi-function Analog Input Ai4	Multi-function Analog input Ai4 Definition ¹⁾	Ai4 Define	Refer to AIO_03~12			
AIO_38	7726		Source Definition ¹⁾	Ai4 Source				
AIO_39	7727		Minimum Voltage ¹⁾	Ai4 In X1				
AIO_40	7728		Minimum Voltage Bias ¹⁾	Ai4 Out Y1				
AIO_41	7729		Maximum Voltage ¹⁾	Ai4 In X2				
AIO_42	772A		Maximum Voltage Gain ¹⁾	Ai4 Out Y2				
AIO_43	772B		Minimum Voltage ¹⁾	Ai4 -In X1				
AIO_44	772C		Minimum Voltage Bias ¹⁾	Ai4 -Out Y1				
AIO_45	772D		Maximum Voltage ¹⁾	Ai4 -In X2				
AIO_46	772E		Maximum Voltage Gain ¹⁾	Ai4 -Out Y2				
AIO_47	772F		Output LPF time constant ¹⁾	Ai4 LPF				
AIO_48	7730		Command loss criterion select ¹⁾	Ai4 Wbroken				
AIO_49	7731	Multi-function Analog Input Ai2	Multi-function Analog input Ai5 Definition ¹⁾	Ai5 Define	Refer to AIO_01 ∫ When using EXTN_I/O motor NTC /PTC function is available at Ai5 17(Use Mot NTC)	0 (Not Used)	No	
AIO_50	7732		Source Definition ¹⁾	Ai5 Source	0 (-10 ⇒ 10V)	-	0 (-10 ⇒ 10V)	No
					1 (10 ⇒ -10V)			
					2 (0 ⇒ 10V)			
					3 (10 ⇒ 0V)			
AIO_51	7733	Minimum Voltage ¹⁾	Ai5 In X1	Refer to AIO_03~12				
AIO_52	7734	Minimum Voltage Bias ¹⁾	Ai5 Out Y1					
AIO_53	7735	Maximum Voltage ¹⁾	Ai5 In X2					
AIO_54	7736	Maximum Voltage Gain ¹⁾	Ai5 Out Y2					
AIO_55	7737	Minimum Voltage ¹⁾	Ai5 -In X1					
AIO_56	7738	Minimum Voltage Bias ¹⁾	Ai5 -Out Y1					
AIO_57	7739	Maximum Voltage ¹⁾	Ai5 -In X2					
AIO_58	773A	Maximum Voltage Gain ¹⁾	Ai5 -Out Y2					
AIO_59	773B	Input LPF time constant ¹⁾	Ai5 LPF					
AIO_60	773C	Command loss criterion select ¹⁾	Ai5 Wbroken					



Function Codes Table

Code No.	Comm. Addr	Code Name	LCD Display	Setting Data			Adjustment During Run
				Range	Unit	Default	
AIO_73	7749	Multi-function Analog input command loss time	Time out	0.1 ~ 120.0	sec	1.0	No
AIO_74	774A	Multi-function analog Output AO1 Definition	AO1 Define	0 (Not Used)	-	0 (Not Used)	No
				1 (Ai1 Value)			
				2 (Ai2 Value)			
				3 (Ai3 Value)			
				4 (Ai4 Value) ²⁾			
				5 (Ai5 Value) ²⁾			
				7 (PreRamp Ref)			
				8 (PostRamp Ref)			
				9 (ASR Inp Ref)			
				11 (Motor Speed)			
				12 (Motor SpdEst) ³⁾			
				13 (Speed Dev)			
				14 (ASR Out)			
				15 Torque Bias			
				16 (PosTrq Limit)			
				17 (NegTrq Limit)			
				18 (RegTrq Limit)			
				19 (Torque Ref)			
				20 (IqeRef)			
				21 (Iqe)			
				22 (Flux Ref)			
				23 (IdeRef)			
				24 (Ide)			
				25 (ACR_Q Out)			
				26 (ACR_D Out)			
				27 (VdeRef)			
				28 (VqeRef)			
				29(Out Amps RMS)			
				30 (Out Volt RMS)			
				31 (Power)			
				32 (DC Bus Volt)			
				33 (Proc PI Ref)			
				34 (PROC PI F/B)			
				35 (Proc PI Out)			
				36 (Line Speed) ¹⁾			
				37 (Tension Out) ¹⁾			
				38 (Diameter) ¹⁾			
				39 (MotNTC Temp)			
				40 (Inv Temp)			
				41 (Inv i2t)			
				AIO_75			
AIO_76	774C	Bias	AO1 Bias	%	0.0	No	
AIO_77	774D	Gain	AO1 Gain	%	100.0	No	
AIO_78	774E	Bias	AO1 Bias	%	0.0	Yes	
AIO_79	774F	Gain	AO1 Gain	%	-100.0	Yes	
AIO_80	7750	Absolute value setting	AO1 ABS	-	0 (No)	No	

Code No.	Comm. Addr	Code Name	LCD Display	Setting Data			Adjustment During Run
				Range	Unit	Default	
AIO_81	7751	Definition	AO2 Define	Refer to AIO_74~78			
AIO_82	7752	Source Definition	AO2 Source				
AIO_83	7753	Bias	AO2 Bias				
AIO_84	7754	Gain	AO2 Gain				
AIO_85	7755	Bias	AO2 Bias				
AIO_86	7756	Gain	AO2 Gain				
AIO_87	7757	Absolute value setting	AO2 ABS				

- *Note 1) Displayed only when WEB mode setting.
2) It is available when Extension I/O (EXTN_I/O) is applied.
3) It will be displayed when CON_01 is set to 'Sensorless'.

■ Sensorless control Group [SLS_ [[]]]

Code No.	Comm. Addr	Code Name	LCD Display	Setting Data			Adjustment During Run
				Range	Unit	Default	
SLS_00	-	Function code selection	Jump Code	1 ~ 23	-		Yes
SLS_01	7D01	Flux estimation time with sensorless control	Flux BD Time	100 ~ 60000	ms	500	Yes
SLS_02	7D02	P gain for flux estimation	FlxEst PGain	0.1 ~ 999.9	%	100.0	Yes
SLS_03	7D03	I gain for flux estimation	FlxEst IGain	0.0 ~ 999.9	%	100.0	Yes
SLS_04	7D04	cut-off frequency for sensorless ASR	ASR Cut-Off	1.0 ~ 600.0		20.0	Yes
SLS_05	7D05	Sensorless ASR P gain 1	ASR P Gain1	0.1 ~ 999.9	%	100.0	Yes
SLS_06	7D06	Sensorless ASR I gain 1	ASR I Gain1	0.1 ~ 999.9	%	100.0	Yes
SLS_07	7D07	Sensorless ASR LPF 1	ASR LPF1	0 ~ 20000	ms	0	Yes
SLS_08	7D08	Sensorless ASR P gain 2	ASR P Gain2	0.1 ~ 999.9	%	50.0	Yes
SLS_09	7D09	Sensorless ASR I gain 2	ASR I Gain2	0.1 ~ 999.9	%	50.0	Yes
SLS_10	7D0A	Sensorless ASR LPF 2	ASR LPF2	0 ~ 20000	ms	0	Yes
SLS_11	7D0B	Switch-over ramp for sensorless ASR	ASR RAMP	10 ~ 10000	ms	1000	Yes
SLS_12	7D0C	Sensorless ASR target speed	ASR TarSpd	0.0 ~ 3600.0	rpm	0.0	No
SLS_13	7D0D	Sensorless P gain	SpdEst PGain	0.1 ~ 999.9		100.0	Yes
SLS_14	7D0E	Sensorless I gain	SpdEst IGain	0.1 ~ 999.9		100.0	Yes
SLS_15	7D0F	Cut-off frequency for sensorless ACR	ACR Cut-off	10.0 ~ 3000.0		1200.0	Yes
SLS_16	7D10	Regeneration avoidance selection	ZeroAvd Sel	0 (No) / 1 (Yes)		1 (Yes)	No
SLS_17	7D11	P gain of sensed speed controller	SensoredKp	0 ~ 10.0000		0.0000	No
SLS_18	7D12	I gain of sensed speed controller	SensoredKi	0 ~ 10.0000		0.0000	No
SLS_19	7D13	P gain of sensorless speed controller	SensorlessKp	0 ~ 10.0000		0.0000	No
SLS_20	7D14	I gain of sensorless speed controller	SensorlessKi	0 ~ 10.0000		0.0000	No
SLS_21	7D15	Command of flux estimation	FluxEst Ref	0.0000 ~ 6.5535		0.0000	No
SLS_22	7D16	Feedback of flux estimation	FluxEst Fbk	0.0000 ~ 6.5535		0.0000	No
SLS_23	7D17	Rs scale	Rs Scale	100.0 ~ 200.0	%	120.0	Yes

- *Note 1) It will be displayed when CON_01 is set to Sensorless.



Function Codes Table

■ Function Group [FUN_ [] []]

FUN Group	Code No.	Code Name	LCD Display Message	Setting Data			R
				Range	Unit	Default	
	FUN_00	Function code selection	Jump Code	1~62			Yes
	FUN_01	RUN/STOP Command selection	RUN/STOP Src	Terminal 1 Terminal 2 Keypad Option		Terminal 1	No
	FUN_02	Speed reference selection	Spd Ref Sel	Analog Keypad 1 Keypad 2 Option		Keypad 1	No
	FUN_03	Stop mode	Stop Mode	Decel Free-run		Decel	No
	FUN_04	Motor Maximum speed	Max Speed	400.0~3600.0	rpm	1800.0	No
	FUN_12	Multi-step speed0	Speed 0	0.0~Max speed	rpm	0.0	Yes
	FUN_13	Multi-step speed1	Speed 1	0.0~Max speed	rpm	0.0	Yes
	FUN_14	Multi-step speed2	Speed 2	0.0~Max speed	rpm	0.0	Yes
	FUN_15	Multi-step speed3	Speed 3	0.0~Max speed	rpm	0.0	Yes
	FUN_16	Multi-step speed4	Speed 4	0.0~Max speed	rpm	0.0	Yes
	FUN_17	Multi-step speed5	Speed 5	0.0~Max speed	rpm	0.0	Yes
	FUN_18	Multi-step speed6	Speed 6	0.0~Max speed	rpm	0.0	Yes
	FUN_19	Multi-step speed7	Speed 7	0.0~Max speed	rpm	0.0	Yes
	FUN_20	JOG speed	JOG Speed	0.0~Max speed	rpm	100.0	Yes
	FUN_21	Dwell speed	Dwell speed	0.0~Max speed	rpm	100.0	Yes
	FUN_22	Dwell time	Dwell time	0.00~30.000	rpm	100.0	Yes
	FUN_36	"S" curve rate 1 in acceleration	Acc S Start	0.0 ~ 50.0	%	0.0	No
	FUN_37	"S" curve rate 2 in acceleration	Acc S End	0.0 ~ 50.0	%	0.0	No
	FUN_38	"S" curve rate 1 in deceleration	Dec S Start	0.0~50.0	%	0.0	No
	FUN_39	"S" curve rate 2 in deceleration	Dec S End	0.0~50.0	%	0.0	No
	FUN_40	Acc time1	Acc Time-1	0.00~6000.0	sec	2.00	Yes
	FUN_41	Dec time1	Dec Time-1	0.00~6000.0	sec	2.00	Yes
	FUN_42	Acc time2	Acc Time-2	0.00~6000.0	sec	3.00	Yes
	FUN_43	Dec time2	Dec Time-2	0.00~6000.0	sec	3.00	Yes
	FUN_44	Acc time3	Acc Time-3	0.00~6000.0	sec	4.00	Yes
	FUN_45	Dec time3	Dec Time-3	0.00~6000.0	sec	4.00	Yes
	FUN_46	Acc time4	Acc Time-4	0.00~6000.0	sec	5.00	Yes
	FUN_47	Dec time4	Dec Time-4	0.00~6000.0	sec	5.00	Yes
	FUN_48	Zero-speed dec time use	Use 0 Dec T	Yes No		No	Yes
	FUN_49	Zero speed dec time	0 Dec Time	0.00~6000.0	sec	0.00	Yes
	FUN_51	Emergency stop dec time	BX Time	0.0~6000.0	sec	0.0	Yes
	FUN_52	Initial motor magnetizing time	PreExct Time	0~10000	ms	0	No
	FUN_53	Hold time	Hold Time	100~10000	ms	1000	No
	FUN_54	Electronic thermal selection	ETH Select	No Yes		No	Yes
	FUN_55	Electronic thermal 1 minute level	ETH 1 min	FUN_54~200	%	150	Yes
	FUN_56	Electronic thermal successive operation level	ETH Cont	50~FUN_53	%	100	Yes
	FUN_57	Drive switching frequency	PWM Freq	2.5~10.0	kHz	10.0	No
	FUN_58	Selecting power-on start	Power-on Run	No Yes		Yes	Yes
	FUN_59	Selecting run after trip reset	RST Restart	No Yes		Yes	Yes
	FUN_60	Number of auto restart	Retry Number	0~10		0	Yes
	FUN_61	Auto retry delay time	Retry Delay	0.0~60.0	sec	1.0	Yes
	FUN_62	Restart delay time after stop command	Restart time	0.00~10.00	sec	0.00	No
	FUN_63	Overspeed error detect level	Overspd level	100.0~130.0	%	120.0	No
	FUN_64	Overspeed error detect time	Overspd time	0.00~2.00	sec	0.00	No

■ Control Group [CON_[][]]

CON Group	Code No.	Code Name	LCD Display Message	Setting Data			R
				Range	Unit	Default	
	CON_00	Function code selection	Jump Code	1 ~ 47			Yes
	CON_01	Control mode selection	Control Mode	Speed Torque		Speed	No
	CON_02	Drive application mode selection	Application	General Vect/ Elevator		General Vect	No
	CON_03	ASR P Gain1	ASR P Gain1	0.0 ~ 200.0	%	5.0	Yes
	CON_04	ASR I Gain1	ASR I Gain1	0 ~ 50000	ms	3000	Yes
	CON_05	ASR input LPF time constant1	ASR LPF1	0 ~ 20000	ms	0	Yes
	CON_06	ASR P Gain2	ASR P Gain2	0.0 ~ 200.0	%	50.0	Yes
	CON_07	ASR I Gain2	ASR I Gain2	0 ~ 50000	ms	300	Yes
	CON_08	ASR input LPF time constant 2	ASR LPF2	0 ~ 20000	ms	0	Yes
	CON_09	Ramp time in gain switching	ASR Ramp	10 ~ 10000	ms	1000	Yes
	CON_10	Gain switching speed	ASR TarSpd	0.0 ~ 3600.0	rpm	0.0	No
	CON_11	Process PID command(Loader)	Proc PID Ref	-100.0 ~ 100.0	%	0.0	Yes
	CON_12	Process PID position standard	Proc Posi Ref	0 ~ 65535	%	0	No
	CON_13	Process PID P gain	Proc PID Kp	0.0 ~ 999.9	%	0.0	Yes
	CON_14	Process PID I gain	Proc PID Kt	0.0 ~ 100.0	%	0.0	Yes
	CON_15	Process PID D gain	PROC PID Kd	0.0 ~ 100.0	%	0.0	Yes
	CON_16	Process PID positive limit	Proc PID Lmt	-100.0 ~ 100.0	%	100	Yes
	CON_17	Process PID negative limit	Proc Neg Lmt	-100.0 ~ 100.0	%	100	Yes
	CON_18	Process PID output LPF time constant	Proc Out LPF	0 ~ 500	ms	0	Yes
	CON_19	Process PID output gain	Proc OutGain	-250.0 ~ 250.0	%	0.0	Yes
	CON_20	Process PID output enable	Proc PID Enb	Disable Enable Terminal		Disable	No
	CON_21	Process PID Hold time	PID Hold time	0~10000	ms	0	No
	CON_22	Draw set up percentage	Draw %	-100.0 ~ 100.0	%	0.0	Yes
	CON_23	Droop control percentage	Droop %	0.0 ~ 100.0	%	0.0	Yes
	CON_24	Droop control minimum speed	Droop MinSPd	0.0 ~ 3600.0	rpm	0.0	Yes
	CON_25	Droop control minimum torque	Droop MinTrd	0.0 ~ 100.0	%	0.0	Yes
	CON_26	Torque reference value selection	Trq Ref Src	None Analog Option		None	No
	CON_27	Torque reference (Loader)	Trq Ref	-180.0~180.0	%	0.0	Yes
	CON_28	Torque limit definition	Trq Lmt Src	Kpd Kpd Kpd Kpd Kpd Ax Kpd Ax Kpd Kpd Ax Ax Ax Kpd Kpd Ax Kpd Ax Ax Ax Kpd Ax Ax Ax Opt Opt Opt		Kpd Kpd Kpd	No
	CON_29	Forward torque limit	Pos Trq Lmt	0.0 ~ 250.0	%	150.0	Yes
	CON_30	Reverse torque limit	Neg Trq Lmt	0.0 ~ 250.0	%	150.0	Yes
	CON_31	Regenerative torque limit	Reg Trq Lmt	0.0 ~ 250.0	%	150.0	Yes
	CON_32	Torque bias selection	Trq Bias Src	None Analog Keypad Option		None	No
	CON_33	Torque bias volume	Trq Bias	-150.0 ~ 150.0	%	0.0	Yes
	CON_34	Torque bias compensation volume of friction factor	Trq Bias FF	-150.0 ~ 150.0	%	0.0	Yes
	CON_35	Torque balance percentage	Trq Bias F	0.0 ~ 100.0	%	50.0	Yes
	CON_49	Speed search selection	Speed search	0000~1111 (Bit set up)		0100	No



Function Codes Table

■ User Group [USR_[] []]

User Group	Code No.	Code Name	LCD Display Message	Control Method				Setting Data			R
				Vector	V/F	SIO	EIO	Range	Unit	Default	
	USR_00	Function code selection	Jump Code					1 ~ 67			Yes
	USR_01	Initializing as applicable field's initial value	Macro Init	○	○	○	○	User Define E/L		User Define	No
	USR_02	User data save	User Save	○	○	○	○	Yes No		No	No
	USR_03	Recall saved user data	User Recall	○	○	○	○	Yes No		No	No
	USR_04	User group data	User Grp	○	○	○	○				No

■ 2nd function group [2nd_[] []]

2nd Group	Code No.	Code Name	LCD Display Message	Setting Data			R
				Range	Unit	Default	
	2nd_00	Function code selection	Jump Code	1 ~ 33			Yes
	2nd_01	2nd motor control mode	2nd Ctl Mode	Speed Torque		Speed	No
	2nd_02	2dn motor maximum speed	2nd Max Spd	400.0 ~ 3600.0	rpm	1800.0	No
	2nd_04	2nd motor multi-step speed 0	2nd Spd 0	0.0 ~ 2nd_02	rpm	0.0	Yes
	2nd_05	"S" curve rate 1 in the 2nd motor acceleration	2nd Acc S St	0.0 ~ 50.0	%	0.0	No
	2nd_06	"S" curve rate 2 in the 2nd motor acceleration	2nd Acc S Ed	0.0 ~ 50.0	%	0.0	No
	2nd_07	"S" curve rate 1 in the 2nd motor deceleration	2nd Dec S St	0.0 ~ 50.0	%	0.0	No
	2nd_08	"S" curve rate 2 in the 2nd motor deceleration	2nd Dec S Ed	0.0 ~ 50.0	%	0.0	No
	2nd_09	The 2nd motor acceleration time	2nd Acc time	0.00 ~ 6000.0	sec	10.00	Yes
	2nd_10	The 2nd motor deceleration time	2nd Dec time	0.00 ~ 6000.0	sec	10.00	Yes
	2nd_11	The 2nd motor cooling method	2nd Cool Mtd	Self-cool Forced-cool		Self-cool	Yes
	2nd_12	Number of encoder pulse of 2nd motor	2nd Enc #	360 ~ 4096		1024	No
	2nd_13	The 2nd motor encoder direction selection	2nd Enc dir	A(B)Phase Lead		A Phase Lead	No
	2nd_14	The 2nd motor encoder error check method	2nd Enc chk	Yes No		Yes	No
	2nd_15	The 2nd motor encoder LPF Time Constant	2nd Enc LPF	0 ~ 100	ms	1	Yes
	2nd_17	The 2nd motor rated speed	2nd RatedSpd	300.0 ~ 3600.0	rpm	1800.0	No
	2nd_18	The 2nd motor rated volt	2nd R-Volt	120 ~ 560	V		No
	2nd_19	The 2nd motor number of poles	2nd Pole #	2 ~ 12		4	No
	2nd_20	The 2nd motor efficiency	2nd Mot Eff	70 ~ 100	%		Yes
	2nd_21	The 2nd motor rated slip	2nd R-Slip	10 ~ 250	rpm		Yes
	2nd_22	The 2nd motor rated current	2nd R-Curr	1.0 ~ 450.0	A		Yes
	2nd_23	The 2nd motor flux current	2nd Fix Cur	70% of 0.0~2nd_22	A		Yes
	2nd_24	The 2nd motor 2nd time constant	2nd Mot Tr	30 ~ 3000	ms		Yes
	2nd_25	The 2nd motor stator inductance	2nd Mot Ls	0.00 ~ 500.00	mH		Yes
	2nd_26	The 2nd motor stator leakage factor	2nd Mot sLs	0.00 ~ 100.00	mH		Yes
	2nd_27	The 2nd motor stator resistance	2nd Mot Rs	0.000 ~ 5.000	ohm		Yes
	2nd_32	The 2nd motor electronic thermal 1 minute level	2nd Eth 1min	100 ~ 150	%	150	Yes
	2nd_33	The 2nd motor electronic thermal continuous operation level	2nd Eth cont	50 ~ 150	%	100	Yes

*Note) The auto furing method of the 2nd motor should be Same with the (PAR_22) and (PAR_23).



Braking Unit and Resistor

1. SV0055iV5-2/4 ~ SV0220iV5-2/4 : Built-in Brake Unit

1) Braking resistor specifications in capacity

Resistance values in the table shown below are calculated based on the 150%, 5%ED standard. In case of 10%ED use, resistor with double rated value should be used. resistors' rated watt.

Type	Applicable Drives	Capacity(5%ED)	
		[R _Ω]	[W]
BR0800W020J	SV 0055iV5-2 DB	20	800
BR01200W015J	SV 0075iV5-2 DB	15	1200
BR2400W010J	SV 0110iV5-2 DB	10	2400
BR2400W008J	SV 0150iV5-2 DB	8	2400
BR3600W005J	SV 0185iV5-2 DB	5	3600
BR3600W005J	SV 0220iV5-2 DB	5	3600
BR1000W085J	SV 0055iV5-4 DB	85	800
BR1200W060J	SV 0075iV5-4 DB	60	1200
BR2400W040J	SV 0110iV5-4 DB	40	2400
BR2400W030J	SV 0150iV5-4 DB	30	2400
BR3600W020J	SV 0185iV5-4 DB	20	3600
BR3600W020J	SV 0220iV5-4 DB	20	3600

▶ ED 100sec standard.

▶ Resistance value is based on the self-cooling standard.

2) Brake resistor wiring

Brake resistor has attached a temperature detectable sensor for fire protection.

See below when in use.

Brake resistor terminal blocks	Drive terminals	Operation
B1, B2	P, BR	
P7, CM	One of the multi function input terminals, out of P1~P7, of control terminals board is used as defining "External trip signal contact B"	The contact is ON in normal temperature and opens in overheat.

2. SV0300iV5-2/4 ~ SV0370iV5-2/4, SV0450iV5-4 ~ SV3750iV5-4

- ① SV037DBH-2: 37kW/200V Class Braking Unit (10% ED)
- ② SV037DBH-4: 37kW/400V Class Braking Unit (10% ED)
- ③ SV075DBH-4: 75kW/400V Class Braking Unit (10% ED)
- ④ SV075DB-4 : 75kW/400V Class Braking Unit (100% ED)
- ⑤ SV220DB-4 : 220kW/400V Class Braking Unit (100% ED)

- The Combination of two braking unit for 400V class is possible for more than SV900iV5-4 capacity.
- When ED is more than 10%, Use the braking unit for 100% ED (Ex: vertical load such as crane, hoist)
- When the drive capacity is more than 220kW, use the braking unit for SV2200DB-4 (100% ED).
- Refer to description manual included in braking unit product for the use of 100% ED braking unit.

1) Combination of braking unit

Drive	SV [] [] [] [] iV5-2	SV [] [] [] [] iV5-4					
		0300 / 0370	0300 / 0370	0450 / 0550 / 0750	0900 / 1100 / 1320 / 1600	2200	2800 / 3150 / 3750
200V	37kW	1					
	37kW		1				
400V	75kW			1	2		
	220kW					1	2

Note) 1. Example) Combine two braking units of 75kW ~ 400V Class for SV-900iV5-4(90kW) Class.

2. Refer to the Braking Unit user manual that came with the braking unit.

2) Braking resistor for braking unit

Braking Unit	100% of Braking Torque, 10% ED	
	Resistance [Ω]	Rated Power [kW]
37kW ~ 200kW	3	5
37kW ~ 400kW	12	5
75kW ~ 400kW	6	10
75kW ~ 400kW	6	Refer to extra manual in the case of 100% ED braking unit.
200kW ~ 400kW	2	

● Terminal functions

Terminal name	Description
P/B1	Connection to drive terminal P2 or P and B2 of braking resistor.
N	Connection to drive terminal N
B2	Connection to brake resistor B2
G	Ground terminal
IN+	Control connection lint(used when SLAVE MODE)
IN-	Control connection lint(used when SLAVE MODE)
OUT+	Control connection lint(used when MASTER MODE)
OUT-	Control connection lint(used when MASTER MODE)
30A/30B/30C	Fault signal output terminal, when the protection function of braking unit operates. 30A : Contact A, 30B : Contact B, 30C COMMON



Braking Unit and Resistor

● Display functions

Displayed item	Description
POWER	Main power in braking unit turns on the POWER LED. Generally the braking unit is wired to Drive so, once the input main power of drive is on the POWER LED of braking unit turns on.
RUN	While braking unit operates its normal operation by the motor regenerative energy, the RUN LED blinks.
OHT	During the braking operation, if the braking unit heat sink is overheated and exceeds its limited value, the overheat protection function operates. This blocks the braking unit signal and then turns on the OHT LED.
OCT	During the braking operation, if over current flows in the main circuit of braking unit inside then the over current protection function is operated in order to prevent the circuit from over current. The TURN ON signal of braking unit is blocked and then turns on the OCT LED.

■ Terminal Block and Braking Unit

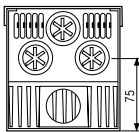
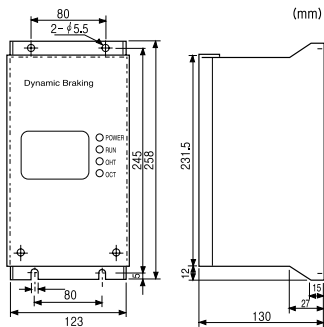

Weight: 2.45kg

Main circuit terminal block

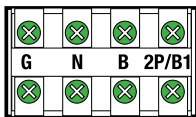

Control circuit terminal

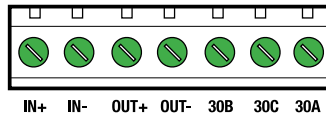

■ Wiring

1) Single use of Braking unit

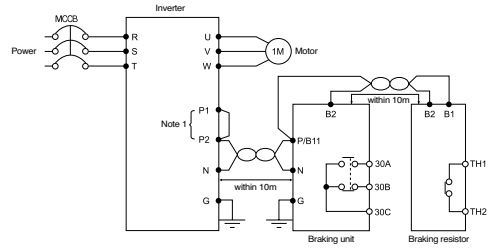

2) Double use of Braking unit

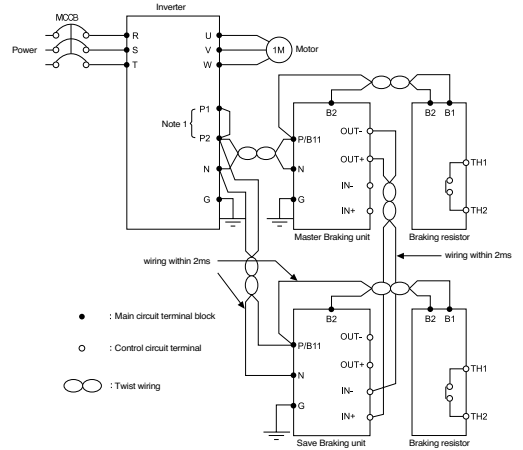

■ Combination of the Braking units and Braking resistors

● 30~37kW(200V/400V)

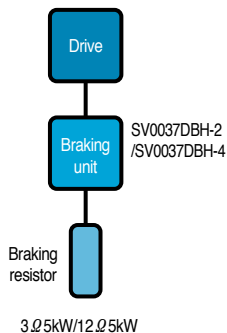

● 45~55kW(200V)

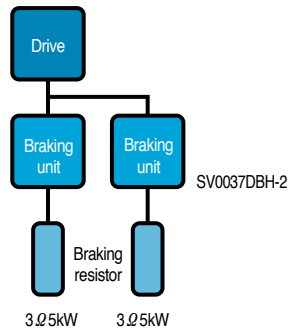

● 45~75kW(400V)

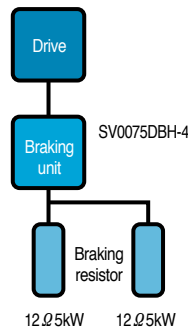

● 90~160kW(400V)

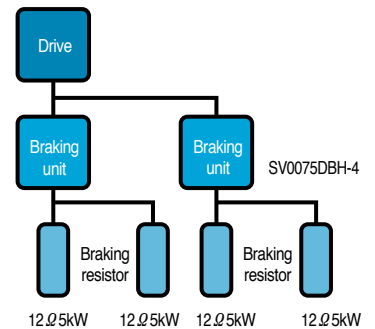

Peripheral Device

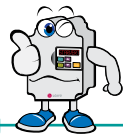

● MCCB (Molded Case Circuit Breaker) and MC (Magnetic Contactor)

Voltage	Capacity [kW]	Circuit Breaker (MCCB)				Leakage Breaker (ELCB)		Magnetic Contactor (MC)		
		Model	Rated Current[A]	Model	Rated Current[A]	Model	Rated Current[A]	Model	Rated Current[A]	
200V	2.2	ABS33c	30	UTE100	100	EBS33c	30	MC-12a/12b	25	
	3.7		30		100		30	MC-18b	32	
	5.5	ABS53c	50	UTE250	150	EBS53c	50	MC-32a	50	
	7.5	ABS63c	60		150	EBS63c	60	MC-40a	60	
	11	ABS103c	125		150	EBS103c	100	MC-65a	100	
	15	ABS403c	250		150	EBS203c	250	MC-75a	110	
	18.5		250	150	250		MC-100a	160		
	22		250	250	250	250	160			
	30		250	250	EBS403c	250	MC-185a	230		
	37	ABS403c	400	UTE400	400		400	MC-225a	275	
400V	2.2	ABS33c	30	UTE100	100	EBS33c	30	MC-9a/9b	25	
	3.7		30				100	30	MC-12a/12b	25
	5.5		30				100	30	MC-18b	32
	7.5		30				150	30	MC-22b	40
	11	ABS53c	50	UTE150	150	EBS53c	50	MC-32a	50	
	15	ABS63c	60		150	EBS63c	60	MC-40a	60	
	18.5	ABS103c	125		150	EBS103c	100	MC-65a	100	
	22		125		150		100	100		
	30	ABS203c	125	UTS250	150	EBS203c	125	MC-85a	135	
	37		250		150		250		135	
	45		250		250		250	250	MC-150a	210
	55		250		250		250	250	210	
	75	ABS403c	400	UTS400	400	EBS403c	400	MC-225a	275	
	90		400		400		400	MC-330a	350	
	110	ABS603c	630	UTS600	600	EBS603c	630	MC-400a	450	
	132		630		600		630	MC-500a	580	
	160	ABS803c	800	UTS800	800	EBS803a	630	MC-630a	660	
	220	ABS1003c	1000		800		800	MC-800a	900	
	280	ABS1203c	1200	UTS1200	1200	EBS1003b	1000	MC-1400a	1400	
	315		1200		1200	EBS1203c	1200		1400	
375	1200		1200		1200		1400			
500	1600A	1600	1600A	1600	1600A	1600	1600A	1600		
800	2400A	2400	2400A	2400	2400A	2400	2400A	2400		

Dimension



1) 2.2 ~ 22kW (200V/400V), Mold Type

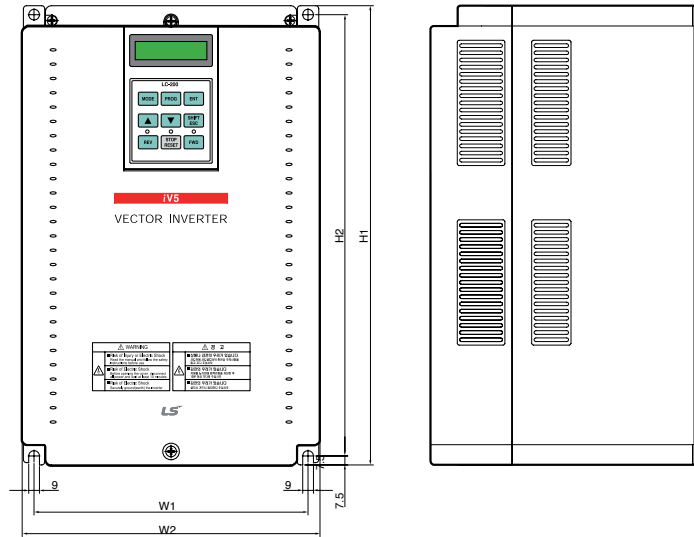
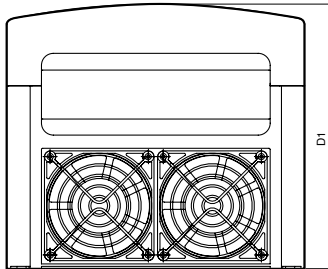

● Dimensions of each capacity (mm[inches])

Drive Model	W1	W2	H1	H2	D1
SV022iV5-2/4DB (MD)			284	269	207
SV037iV5-2/4DB (MD)	200	180	[11.18]	[10.69]	[8.15]
SV055iV5-2/4DB (MD)	[7.87]	[7.09]	355	340	202
SV075iV5-2/4DB (MD)			[13.97]	[13.38]	[7.95]
SV110iV5-2/4DB (MD)	250	230	385	370	221
SV150iV5-2/4DB (MD)	[9.84]	[9.06]	[15.16]	[14.57]	[8.70]
SV185iV5-2/4DB (MD)	304	284	460	445	254
SV220iV5-2/4DB (MD)	[11.97]	[11.18]	[18.11]	[17.52]	[10.00]

2) 5.5 ~ 22kW (200V/400V/DC Input Type)

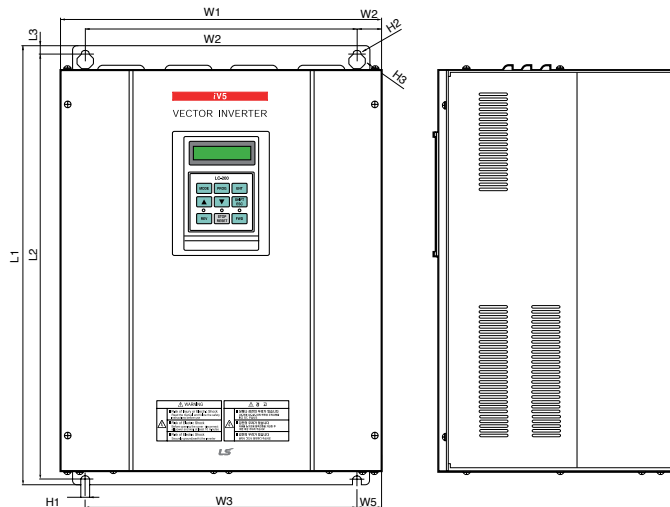
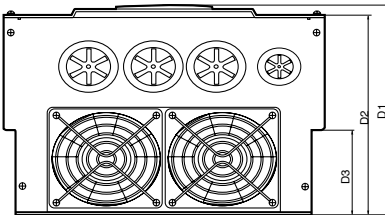

● Dimensions of each capacity (mm[inches])

Drive Model	W1	W2	W3	W4	W5	L1	L2	L3	D1	D2	D3	H1	H2	H3
SV055iV5-2/4DB	234.4	180	180	27.2	27.2	406.2	391.2	7.5	221.1	209.5	75	6	∅ 6	∅ 12
SV075iV5-2/4DB	[9.22]	[7.08]	[7.08]	[1.07]	[1.07]	[15.9]	[15.4]	[0.29]	[8.7]	[8.24]	[2.95]	[0.23]		
SV110iV5-2/4DB														
SV150iV5-2/4DB	335	284	284	25.5	25.5	526	509	10	248.6	237	100	7	∅ 7	∅ 14
SV185iV5-2/4DB	[13.1]	[11.1]	[11.1]	[1.00]	[1.00]	[20.7]	[20.0]	[0.39]	[9.78]	[9.33]	[3.93]	[0.27]		
SV220iV5-2/4DB														

3) 30 ~ 37kW (200V)
 30 ~ 75kW (400V)
 30 ~ 75kW (DC Input Type)

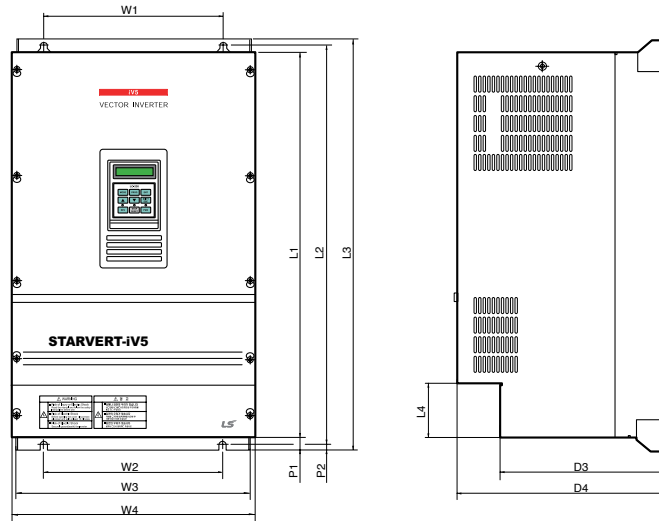
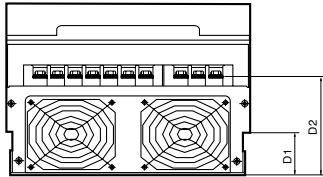

• Dimensions of each capacity (mm[inches])

Drive Model	W1	W2	W3	W4	L1	L2	L3	D1	D2	D3	D4	P1	P2
SV300iV5-2/4	270	270	319.2	350	635	660	680	120	197	256.6	308.2	16.9	8
SV370iV5-2/4	[10.6]	[10.6]	[12.5]	[13.7]	[25.0]	[26.0]	[26.7]	[4.72]	[7.76]	[10.1]	[12.1]	[0.66]	[0.31]
SV450iV5-4	275	275	359.6	375	730.6	758.5	780	82.3	189.3	259	326	24.5	10.5
SV550iV5-4	[10.8]	[10.8]	[14.1]	[14.7]	[28.7]	[29.8]	[30.7]	[3.24]	[7.45]	[10.2]	[12.8]	[0.90]	[0.41]

4) 90 ~ 160kW (400V)
 90 ~ 160kW (DC Input Type)

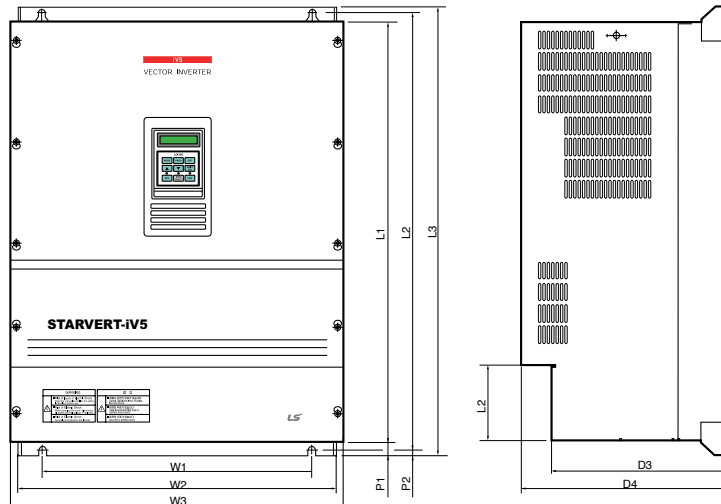
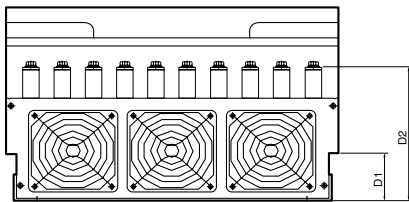

• Dimensions of each capacity (mm[inches])

Drive Model	W1	W2	W3	L1	L2	L3	D1	D2	D3	D4	P1	P2
SV900iV5-4	430	507	530	729	760	780	83.2	234.6	286.2	335	23.5	8.5
SV1100iV5-4	[16.9]	[19.9]	[20.8]	[28.7]	[29.9]	[30.7]	[3.27]	[9.23]	[11.2]	[13.2]	[0.92]	[0.33]
SV1320iV5-4	430	507	530	949	980	1000	95.2	231.6	298	345	23.5	8.5
SV1600iV5-4	[16.9]	[19.9]	[20.8]	[37.3]	[38.5]	[39.3]	[3.75]	[9.12]	[11.7]	[13.5]	[0.92]	[0.33]



Dimension

5) 220kW (400V) 220kW (DC Input Type)

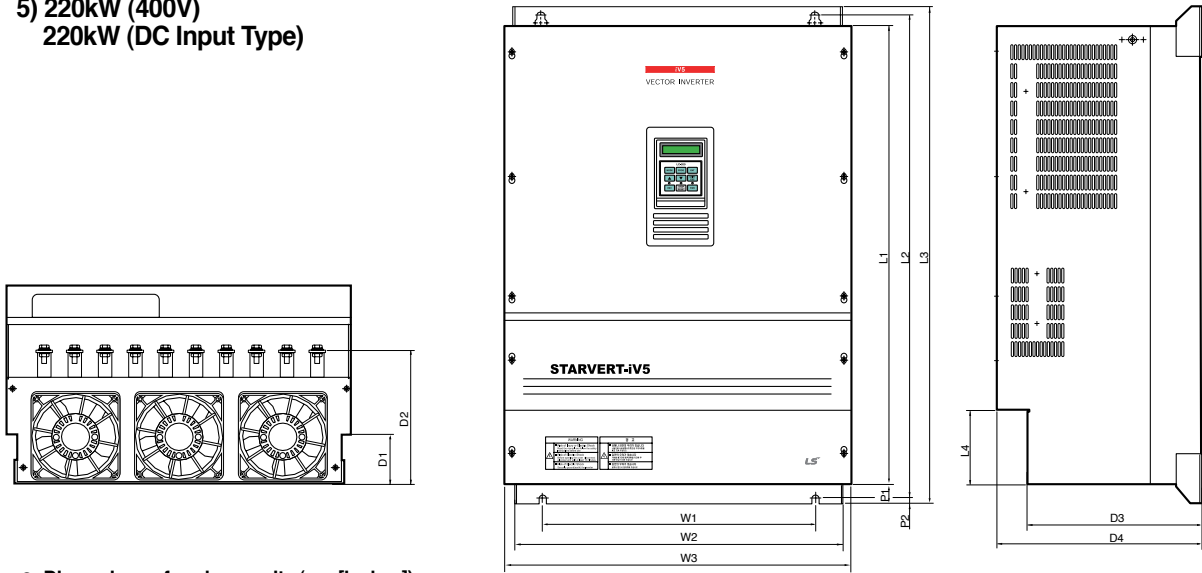

● Dimensions of each capacity (mm[inches])

Drive Model	W1	W2	W3	L1	L2	L3	L4	D1	D2	D3	D4	P1	P2
SV2200iV5-4	540 [21.26]	649 [25.55]	680 [26.77]	922 [36.3]	968.5 [38.13]	998 [39.29]	150 [5.91]	100.2 [3.94]	271 [10.67]	343 [13.5]	403 [15.87]	38 [1.49]	12 [0.47]

6) 280~375kW (400V) 280~375kW (DC Input Type)

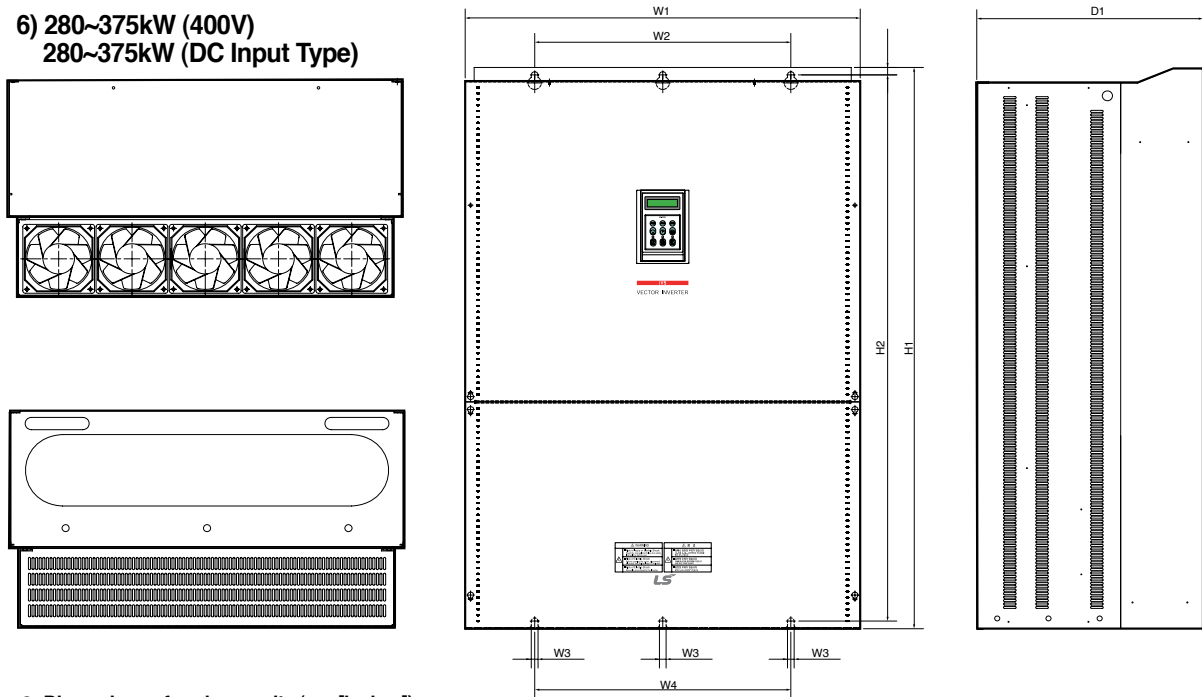

● Dimensions of each capacity (mm[inches])

Drive Model	W1	W2	W3	W4	D1	H1	H2
SV2800iV5-4	772 [30.39]	500 [19.69]	13 [0.51]	500 [19.69]	1140.5 [44.90]	1110 [43.70]	442 [17.40]
SV3150iV5-4	922	580	14	580	1302.5	1271.5	495
SV3750iV5-4	[6.30]	[22.83]	[0.55]	[22.83]	[51.28]	[50.06]	[19.49]

7) 500kW (400V)
500kW (DC Input Type)

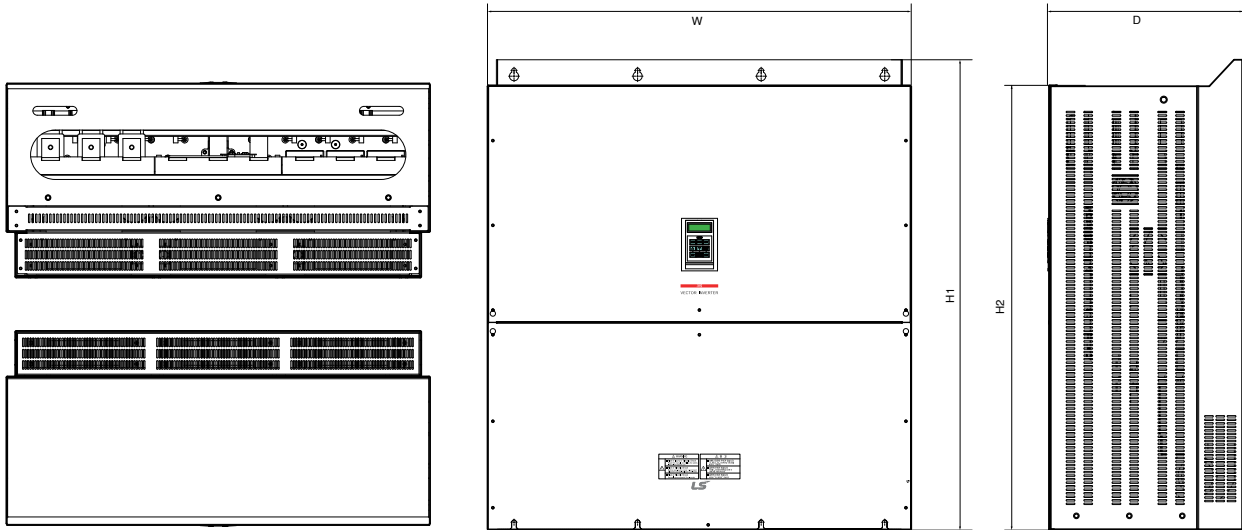

● Dimensions of each capacity (mm[inches])

DC has a same dimension as AC.

Drive Model	W1	W3	H1	D1
SV5000iV5-4	1200 [30.39]	1330 [44.90]	1260 [43.70]	550 [17.40]

8) 7.5 ~ 11kW (MRL)

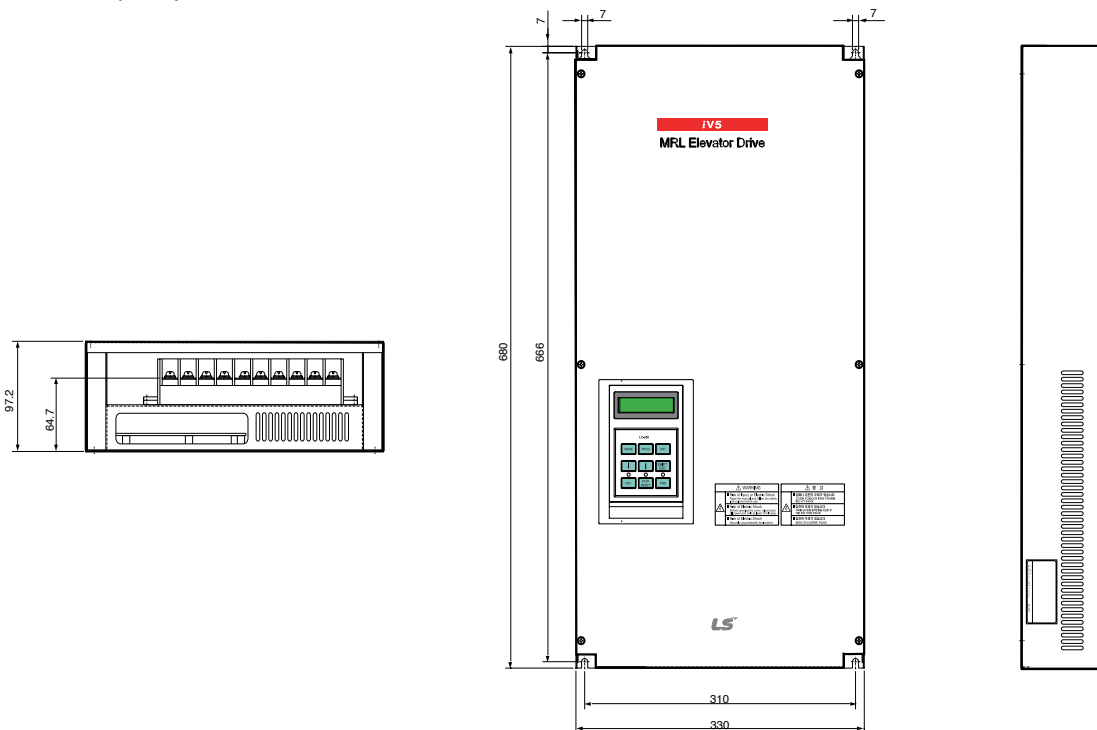

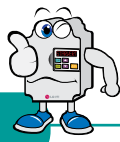

Dimension

9) 15kW (MRL)

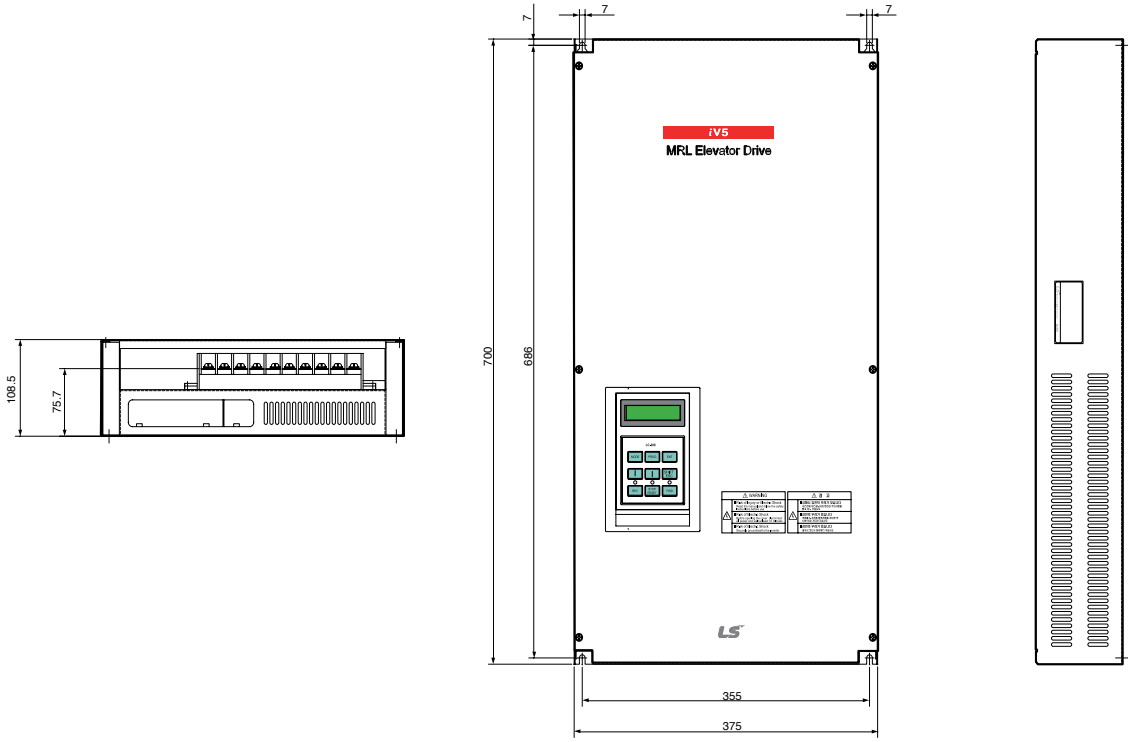

10) 22kW (MRL)

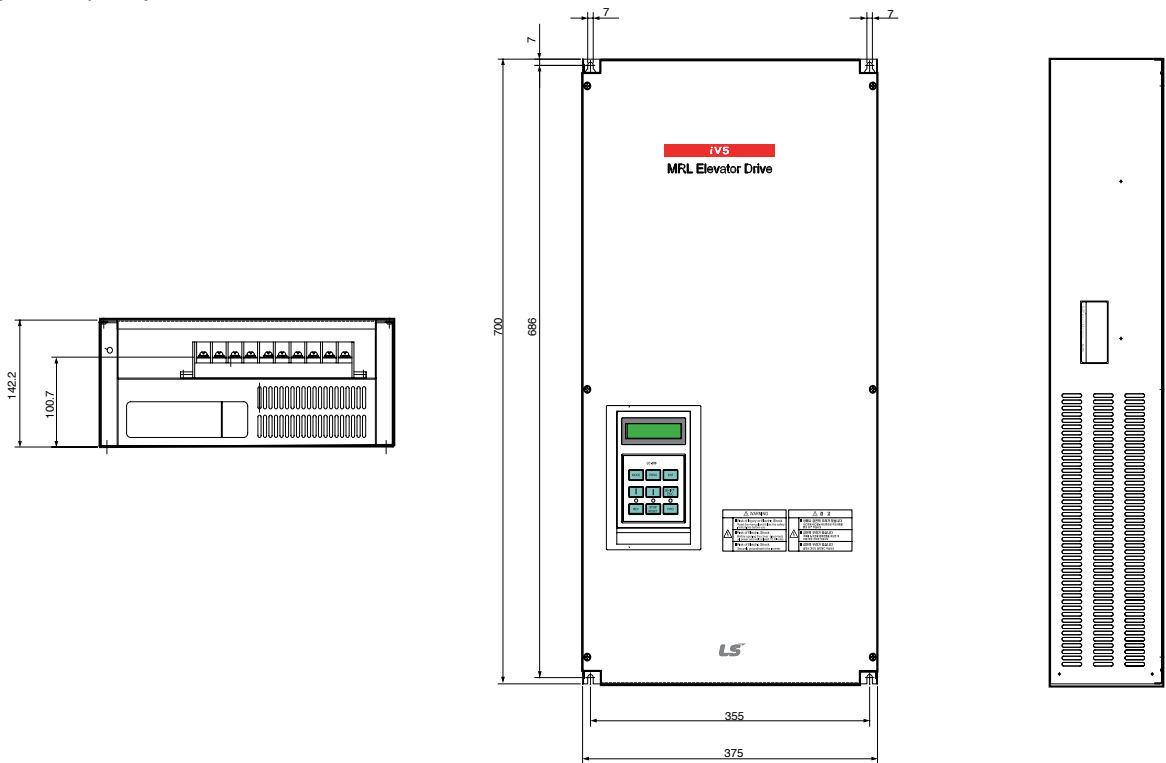



Fault Solution and Check

■ Fault Display

Drive faults activate its protection functions which enable the alarm operation and each fault status is displayed in the loader. Refer to table shown below for the LCD loader displays.

Protection function	LCD Display	Description
Over current	OC-U OC-V OC-W	Drive turns off its output when the output current of the drive flows more than 200% of the drive rated current.
Ground fault protection	Ground Fault	Drive turns off its output when a ground fault occurs and the ground fault current is more than the internal setting value of the drive. Over current trip function may protect the drive when a ground fault occurs due to a low ground fault resistance.
Over voltage protection	Over Voltage	Drive turns off its output if the DC voltage of the main circuit increases higher than the rated value (200V series : 400V DC, 400V Series : 800V DC) when the motor decelerates or when regenerative energy flows back to the drive due to a regenerative load. This fault can also occur due to a surge voltage generated at the power supply system.
Low voltage protection	Low Voltage	Drive turns off its output if the DC voltage is below the rated level(200V Series: 200VDC, 400V Series : 400Vdc) because insufficient torque or over heating of the motor can occurs when the input voltage of the drive drops.
Over load trip (Over load protection)	Over Load	Drive turns off its output if the output current of drive is over 180% of motor rated current and over load trip time. (only applicable to over 90kW drives and also V/F control mode)
Fuse open	Fuse Open	Drive turns off its output by opening the fuse when something is wrong with the main circuit IGBT to protect the wiring from being damaged from short currents
Drive over heat	InvOver Heat	Drive turns off its output if the heat sink over heats due to a damaged cooling fan or an alien substance in the cooling fan by detecting the temperature of the heat sink.
Drive NTC thermister open	InvThem OP	Drive turns off its output if the NTC Thermister, which measures the temperature of drive, is open.
Motor over heat	MotOver Heat	Drive turns off its output if the motor is over-heated to protect the motor. This protective function prevents the motor from over heat.
Motor NTC thermister open	MotThem OP	Drive turns off its output if the NTC Thermister, which measures the motor temperature, is open.
Electronic thermal	E-Thermal	Internal electronic thermal of the drive determines the over heating of the motor. If the motor is overloaded the drive turns off the output. Drive cannot protect the motor when driving a multi-pole motor or when driving multiple motors, so consider thermal relays or other thermal protective devices for each motor.
External fault	Ext Trip-B	This is used if the user wants to turn off the drive output due to external fault signal.
IGBT short	Arm short-U Arm short-V Arm Short-W Arm Short-DB	Drive turns off its output if IGBT Arm or output shorts occur.
Encoder error	Encoder Err	This is displayed if there is a problem of encoder signal.
BX Protection (Instant cut off)	BX	Used for the emergency stop of the drive. The drive instantly turns off the output when the BX terminal is turned ON, and returns to regular operation when the BX terminal is turned OFF. Take caution when using this function.
Motor over speed	Over Speed	The motor runs exceeding 120% of its maximum default speed.
Communication error	COM Error CPU Error	This is displayed if there is any types of communication errors between the drive main and loader.

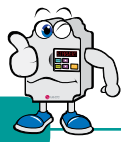

Basic configuration

Proper peripheral devices must be selected and correct connections made to ensure proper operation. An incorrectly applied or installed drive can result in system malfunction or reduction in product life as well as component damage. You must read and understand this manual thoroughly before proceeding.



AC source supply

Use the power supply within the permissible range of drive input power rating.

MCCB or Earth leakage circuit breaker (ELB)

Select circuit breakers with care. A large inrush current may flow in the drive at power on.

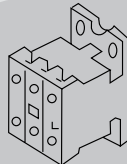
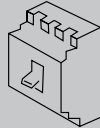

Magnetic contactor

Install it if necessary. Installed, do not use it for the purpose of starting or stopping. Otherwise, it could lead to reduction in product life.

AC reactor

The AC reactor must be used when the power factor is to be improved or the drive is installed near a large power supply system (1000kVA or more and wiring distance within 10m).

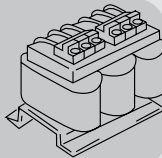

Installation and wiring

To operate the drive with high performance for a long time, install the drive in a proper place in the correct direction and with proper clearances. Incorrect terminal wiring could result in the equipment damage.

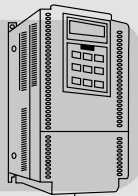

Ground

DC reactor

It is required for drives 5.5kW~22kW (200/400V). Not necessary for drives below 3.7kW.

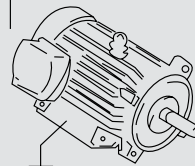
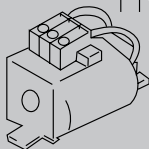

To motor

Do not connect a power factor capacitor, surge suppressor or radio noise filter to the output side of the drive.

Ground

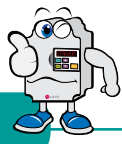

Memo

A large, empty, light blue rectangular area intended for writing a memo.

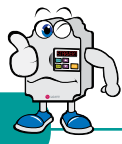

Memo

A large, empty, light blue rectangular area intended for writing a memo.

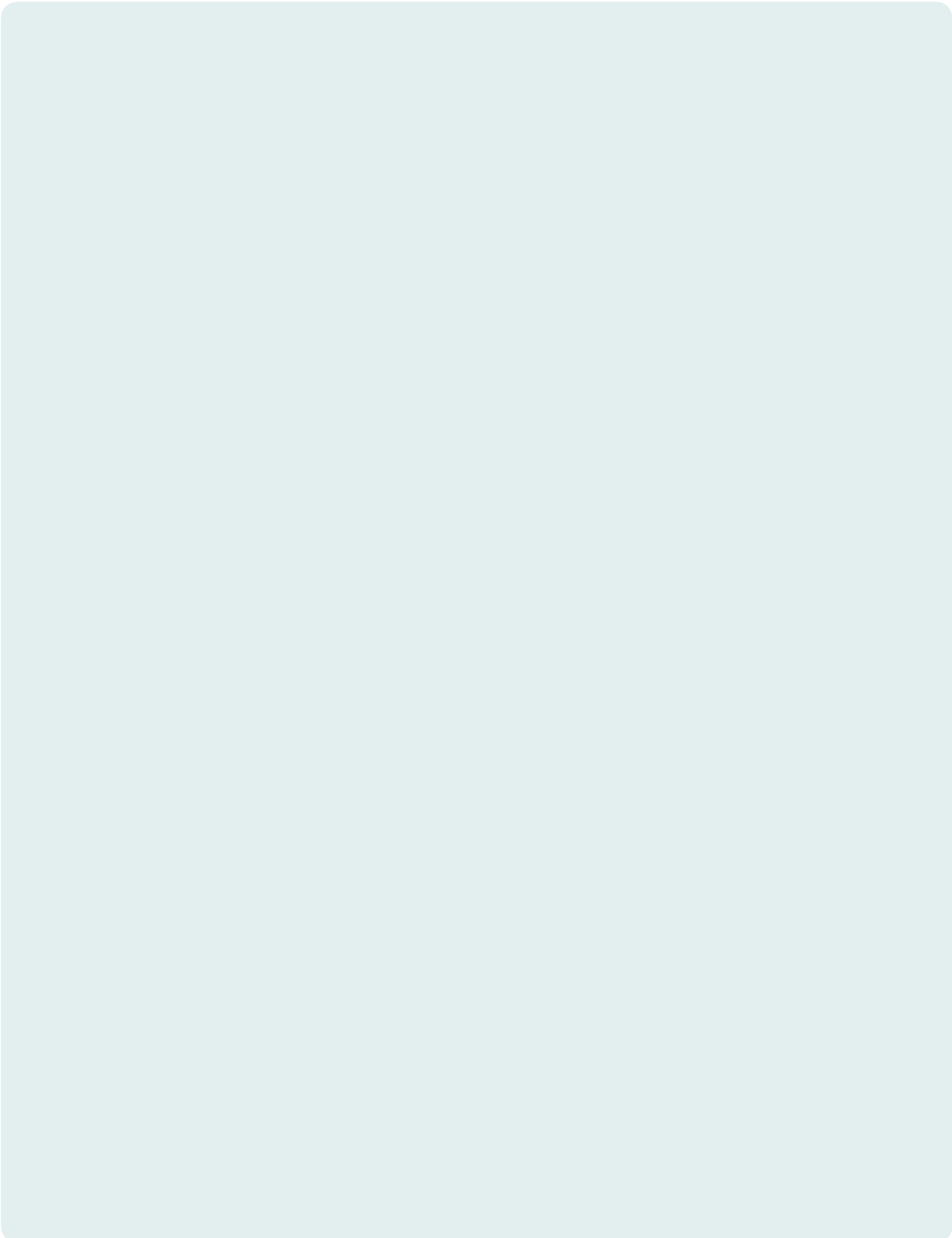

Green Innovators of Innovation



Safety Instructions

- For your safety, please read user's manual thoroughly before operating.
- Contact the nearest authorized service facility for examination, repair, or adjustment.
- Please contact a qualified service technician when you need maintenance. Do not disassemble or repair by yourself!
- Any maintenance and inspection shall be performed by the personnel having expertise concerned.

LSIS Co., Ltd.

© 2013.01 LSIS Co., Ltd. All Rights Reserved.

www.lsis.com

■ HEAD OFFICE

LS Tower, 127, LS-ro, Dongan-gu, Anyang-si, Gyeonggi-do, Korea

- EMEA +82-2-2034-4901 / bonseongk@lsis.com
- Asia Pacific / Americas +82-2-2034-4620 / mswoo@lsis.com

Overseas Subsidiaries

- **LSIS(Dalian) Co., Ltd., Dalian, China**
No. 15, Liaohexi 3-Road, Economic and Technical Development Zone, Dalian 116600, China
Tel : 86-411-8730-7510 / Fax : 86-411-8730-7560
- **LSIS(Wuxi) Co., Ltd., Wuxi, China**
No. 1, Lexing Road, Wuxi National High & New Tech Industrial Development Area, Wuxi214028, Jiangsu, P.T.China
Tel : 86-510-8534-6666-8005 / Fax : 86-510-8534-4078
- **LS Hukai Electric(Hubei) Co., Ltd., Hubei, China**
No. 100, Tanjiahe Road, Dianjun District, Yichang City, Hubei Province, 443004, China
Tel : 86-717-667-7339 / Fax : 86-717-667-7559
- **LS-VINA Industrial Systems Co., Ltd., Hanoi, Vietnam**
Nguyen Khe, Dong Anh, Hanoi, Vietnam
Tel : 84-4-6275-8055 / Fax : 84-4-3882-0220
- **LSIS(ME) FZE_Dubai, U.A.E.**
LOB 19-205, JAFZA View Tower, Jebel Ali Free Zone, Dubai, United Arab Emirates
Tel : 971-4-886-5360 / Fax : 971-4-886-5361
- **LSIS Europe B.V., Netherlands**
1st. Floor, Tupolevlaan 48, 1119NZ, Schiphol-Rijk, The Netherlands
Tel : 31-20-654-1420 / Fax : 31-20-654-1429
- **LSIS Japan Co., Ltd., Tokyo, Japan**
Tokyo Club Building 13F, 2-6, Kasumigaseki 3-chome, Chiyoda-ku, Tokyo, 100-0013
Tel : 81-3-6268-8241 / Fax : 81-3-6268-8240
- **LSIS USA Inc., Chicago, U.S.A.**
2000 Millbrook Drive, Lincolnshire, Chicago, IL 60069, United States
Tel : 847-941-8240 / Fax : 847-941-8259

Specifications in this catalog are subject to change without notice due to continuous product development and improvement.

Overseas Branches

- **LSIS Shanghai Office, China**
32nd Floor, International Corporate City, No.3000 NorthZhongshan Road, Putuo District, Shanghai, China, 200063
Tel : 86-21-5237-9977 / Fax : 86-21-5237-7189
- **LSIS Beijing Office, China**
Room 2306, Building B Landgent Center, No.24 Middle Road, East 3rd Ring Road, Chaoyang District, Beijing, P.R. China
Tel : 86-10-5761-3127 / Fax : 86-10-5761-3128
- **LSIS Guangzhou Office, China**
Room 1818-1820, Xinyuan Building, NO.898 Tianhe North Road, Tianhe District, Guangzhou, P.R. China
Tel : 86-20-8326-6784 / Fax : 86-20-8326-6287
- **LSIS Qingdao Office, China**
Room 2001, Galaxy Building, 29 ShanDong Road, ShiNan District, QingDao, ShanDong, P.R. China
Tel : 86-532-8501-6058 / Fax : 86-532-8501-6057
- **LSIS Chengdu Office, China**
Room1710, 17/F Huamin Empire Plaza, NO.1 Fuxin Road, Chengdu, P.R. China
Tel : 86-28-8670-3200 / Fax : 86-28-8670-3203
- **LSIS ShenYang Office, China**
Room 803, Hongyuan Building, 52 South Nanjing Road, Heping District, Shenyang, P.R. China
Tel : 86-24-2321-9050 / Fax : 86-24-8386-7210
- **LSIS Jinan Office, China**
Room 317, Chuangzhan Center, No. 201, Shanda Road, Lixia District, Jinan, Shandong, P. R. China
Tel : 86-531-8699-7826 / Fax : 86-531-8697-7628
- **LSIS Co., Ltd. Tokyo Office, Japan**
Tokyo Club Building 13F, 2-6, Kasumigaseki 3-chome, Chiyoda-ku, Tokyo, 100-0013
Tel : 81-3-6268-8241 / Fax : 81-3-6268-8240
- **LSIS Co., Ltd. Rep. Office, Vietnam**
Gema Dept Tower 18F, 6 Le Thanh Ton, District 1, HCM, Vietnam
Tel : 84-8-3823-7890
- **LSIS Detroit Office, U.S.A.**
5700 Crooks Rd, Suite 211, Troy, MI 48098, USA
Tel : 1-248-792-2637-8 / Fax : 1-248-792-2642
- **LSIS Co., Ltd. India Office, India**
109 First Floor, Park Central, Sector-30, Gurgaon- 122 002, Haryana, India
Tel : 91-1244-930-077 / Fax : 91-1244-930-066
- **LSIS Moscow Office, Russia**
123610, Krasnopresnenskaya, nab., 12, building 1, office №1005, Moscow, Russia
Tel : 7-495-258-1466/1467 / Fax : 7-495-258-1466/1467
- **LSIS U.K. Office, United Kingdom**
G17 Bedford I-Lab, Stannard Way, Priory Business Park, Bedford, MK44 3RZ, U.K.
Tel : 44-012-3483-4774 / Fax : 44-012-3483-4775